

A revolutionary MPDP

Infinitely Expandable **MPDP**

A revolutionary MPDP
Infinitely Expandable MPDP

ORION PDP CO.,LTD.
www.oriondisplay.net

Address: 257-6, Gongdan-dong, Gumi-si, Gyeongsangbuk-do, Korea
Tel : +82-2-6678-8533, Fax: +82-2-6678-8599



User's Manual **OPM-4250 | OPM-4250R**

Thank you for purchasing our MPDP.
Please read through this user's manual for safety before installing this product.
This product is manufactured for Multi Plasma display model only.

Features of MPDP

- ▶ Enjoy a wide flat screen with high brightness and high quality.
- ▶ Easy to install and move due to its thin design
- ▶ Enjoy your favorite programs with various split-screen features simultaneously presenting several programs.

Thank you for purchasing our MPDP monitor.

This manual describes how to use the product and notes in use.
 Please read the manual carefully before using it.
 After reading this manual, please retain for future reference.
 If you have any questions or a problem occurs, please contact either the company you purchased this product from or an authorized service center.

※ **Displaying static picture for an extended period of time may cause an burn-in effect.**

 **Warning** If you fail to comply with the regulations for safety and proper use, fire or injury may be caused.

 **Warning** To prevent electric shock, Do not remove cover.
 No user serviceable part inside
 Refer servicing to qualified service personal.

Supplied Accessories

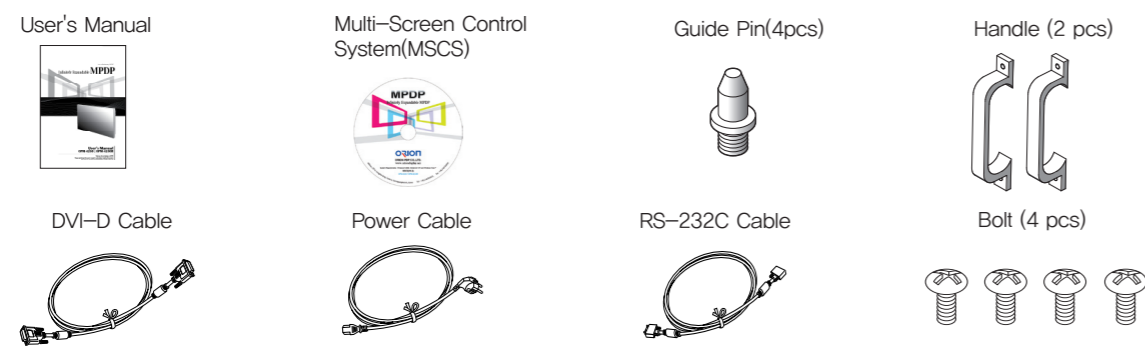

Optional Accessories

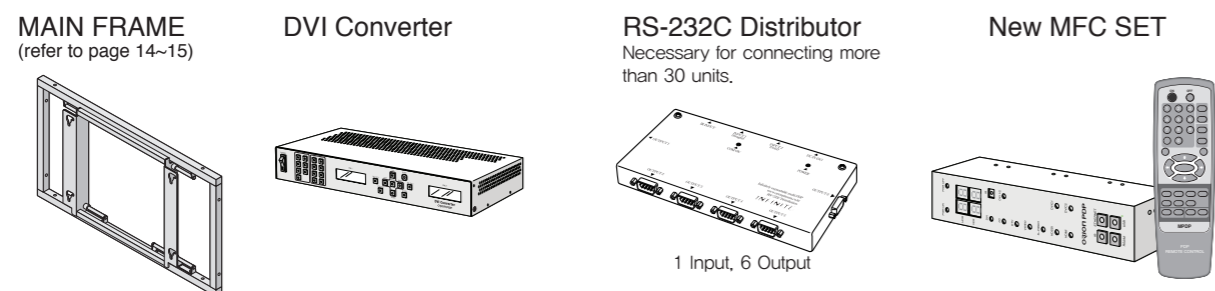



Notice to users

Class A digital device

It is a device designed for business purpose with a safety certificate for electromagnetic interference, which user should be mindful of.

" Important Safety Instructions"

- 1) Read these instructions.
- 2) Keep these instructions.
- 3) Heed all warnings.
- 4) Follow all instructions.
- 5) Do not use this apparatus near water.
- 6) Clean only with dry cloth.
- 7) Do not block any ventilation openings. Install in accordance with the manufacturer's instructions.
- 8) Do not install near any heat sources such as radiators, heat registers, stoves, or other apparatus (including amplifiers) that produce heat.
- 9) Do not defeat the safety purpose of the polarized or grounding-type plug. A polarized plug has two blades with one wider than the other. A grounding type plug has two blades and a third grounding prong. The wide blade or the third prong are provided for your safety. If the provided plug does not fit into your outlet, consult an electrician for replacement of the obsolete outlet.
- 10) Protect the power cord from being walked on or pinched particularly at plugs, convenience receptacles, and the point where they exit from the apparatus.
- 11) Only use attachments/accessories specified by the manufacturer.
- 12) Use only with the cart, stand, tripod, bracket, or table specified by the manufacturer, or sold with the apparatus. When a cart is used, use caution when moving the cart/apparatus combination to avoid injury from tip-over. 
- 13) Unplug this apparatus during lightning storms or when unused for long periods of time.
- 14) Refer all servicing to qualified service personnel. Servicing is required when the apparatus has been damaged in any way, such as power-supply cord or plug is damaged, liquid has been spilled or objects have fallen into the apparatus, the apparatus has been exposed to rain or moisture, does not operate normally, or has been dropped.
 The symbol in figure 21 shall be shown adjacent to the text of item 12 above.

	CAUTION RISK OF ELECTRIC SHOCK DO NOT OPEN	
<p>CAUTION : TO REDUCE THE RISK OF ELECTRIC SHOCK, DO NOT REMOVE COVER (OR BACK). NO USER-SERVICEABLE PARTS INSIDE. REFER SERVICING TO QUALIFIED SERVICE PERSONNEL.</p>		



This symbol is intended to alert the user to the presence of uninsulated "dangerous voltage" within the product's enclosure that may be of sufficient magnitude to constitute a risk of electric shock to persons.



This symbol is intended to alert the user to the presence of important operating and maintenance(servicing) instructions in the literature accompanying the appliance.

NOTICE

1. To disconnect the apparatus from the mains, the plug must be pulled out from the mains socket, therefore the mains plug shall be readily operable
2. WARNING - To Reduce The Risk Of Fire Or Electric Shock, Do Not Expose This Appliance To Rain Or Moisture.
3. Apparatus shall not be exposed to dripping or splashing and no objects filled with liquids, such as vases, shall be placed on the apparatus.
4. Use only a properly grounded plug and receptacle
5. "Warning" CAUTION – These servicing instructions are for use by qualified service personnel only. To reduce the risk of electric shock, do not perform any servicing other than that contained in the operating instructions unless you are qualified to do so.
6. "Warning" CAUTION – These servicing instructions are for use by qualified service personnel only. To reduce the risk of electric shock, do not perform any servicing other than that contained in the operating instructions unless you are qualified to do so.

Contents

- ※ Cautions for consisting MPDP System4
- ※ Please keep following instruction for panel protection without exception,6
- 1. Safety Precautions.....10
- 2. How to Install.....12
- 3. Guidance for Users.....16
- 4. How to Connect Cables18
 - 4.1. Connection of one set MPDP.....18
 - PC & DVI Connection.....18
 - 4.2. Connection of Multi–screen MPDP.....20
 - 4.3. Connection of RS–232C Cable.....22
 - 4.4. Connection of 3 x 3 MPDP.....23
 - 4.5. DVI Connection.....24
 - 4.6. ID setting of X x Y MPDP25
- 5. Setting and operation of MSCS software26
 - 5.1. MSCS Installation26
 - 5.2. Start MSCS.....27
 - 5.3. Setting 'Com Port'28
 - 5.4. Port Setting.....29
 - 5.5. "New design/Last design" setting30
 - 5.6. Multi–screen configuration.....31
 - 5.7. MSCS Instruction.....32
 - 5.8. ID Setting32
 - 5.10. Slide Control.....36
 - 5.11. Screen Control.....39
 - 5.12. BIC Control40
 - BIC status Indicator.....42
 - Burn–In–Compensation Control Method.....43
 - BIC Intervals and effect.....43
 - How to Control BIC44
 - 5.13. New MFC configuration method46
 - 5.14. DVI Converter49
 - 5.15. Orion PDP Home Page log on and Version information57
- 6. MSCS Protocol.....58
 - ※ Attachment : ASCII to HEX Conversion Table77
- 7. Other tips78
 - 7.1. Before calling for service.....78
 - 7.2. About Plasma display panel.....79
- 8. Applicable DVI signals80
- 9. Specification81
- 10. Option Specification83
 - 10.1. DVI Converter83
 - 10.2. New MFC.....84

※ Cautions for consisting MPDP System

The number of Daisy chain connection

- The image quality can be vary depend on the quality of signal and cable condition.

INPUT SOURCE	Resolution	Connection	Remark
DVI	1600 x 1200 x 60HZ	6 sets	HDCP Available
RS-232C		30 sets	ORION Cable Only

- If you need to use more MPDP sets than indicated in the table, using a DVI distributor is highly recommended.

Cautions for using Wall controller and Application devices

- If you use MVP, Crestron, Extron, AMX, or Jupiter devices instead of MSCS, MPDP Control Program, to consist multi screen, APL function must be turned off to prevent possible brightness difference between sets.

Caution for the other control program besides MPDP Control Program (MSCS)

- If you want to use automatic power on/off function that make MPDP turned on/off by connecting main power, allow at least 20 seconds of Stand-by time before MPDP is turned on, when you make control program.
- BIC function requires two-way communication. If you do not use MSCS, there will be white balance difference by global data as time elapses. To avoid such error, New MFC must be used.
- If RS-232C communication signal or other image signal is applied to 9 or more sets simultaneously, communicational error may occur. (Power on & Broadcast)

Environmental condition for installation

- Since MPDP panel is very sensitive for physical impact, installation requires considerable caution.
- Minimum clearance(20cm) must be secured for smooth ventilation. (See P14~15) Installation must avoid air tight or near air tight places. Improper ventilation causes malfunction and shortens product lifetime by rapid internal temperature rise. If MPDP has to installed at the improper ventilation, additional ventilation openings or fans must be provided to keep the internal temperature between 0 ~ 35°C.
- For ground of MPDP and application devices, it should be connected as frame ground.
- Considering MPDP Max power consumption, check the main electric specification.

Consideration for easier service

- When you design the exterior design for MPDP system, consider easier disassembly for possible service occasion in the future.
- The sliding Universal Unit of ORION PDP is recommended for easier service.
- If service people can step into the backside of MPDP system, it can greatly reduce time and effort for service.
- In case of higher locations, consider the installation location and exterior design for easier service.

WARNING



※ Please keep following instruction for panel protection without exception.

- This product can be damaged even with minor impact for its nature. Please keep following instruction to carry or store the products.



※ Handle with Caution.

- Shock/Impact on the set's sides will result in internal circuit damages.
- The edge/bottom of the panel are fragile. Use shock-absorbing pads or rugs for laying down the product.

WARNING

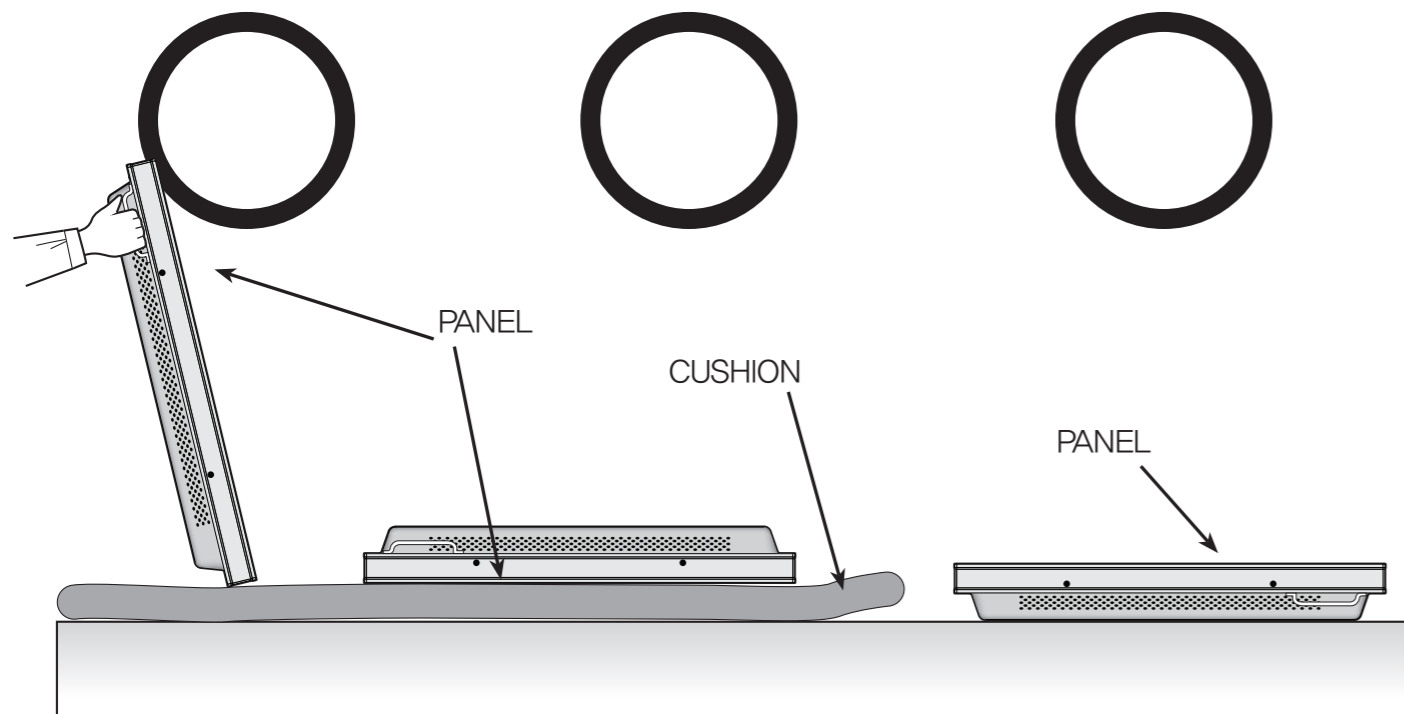

- If you need to stand PDP, you must use handles on the back and lean over the PDP to avoid panel touches ground or floor.

- If you need to lay down PDP as face down position, please use shock-absorbing pads under the PDP.

- If you need to lay down PDP as face up position, please be cautious for falling objects on the surface of the PDP.

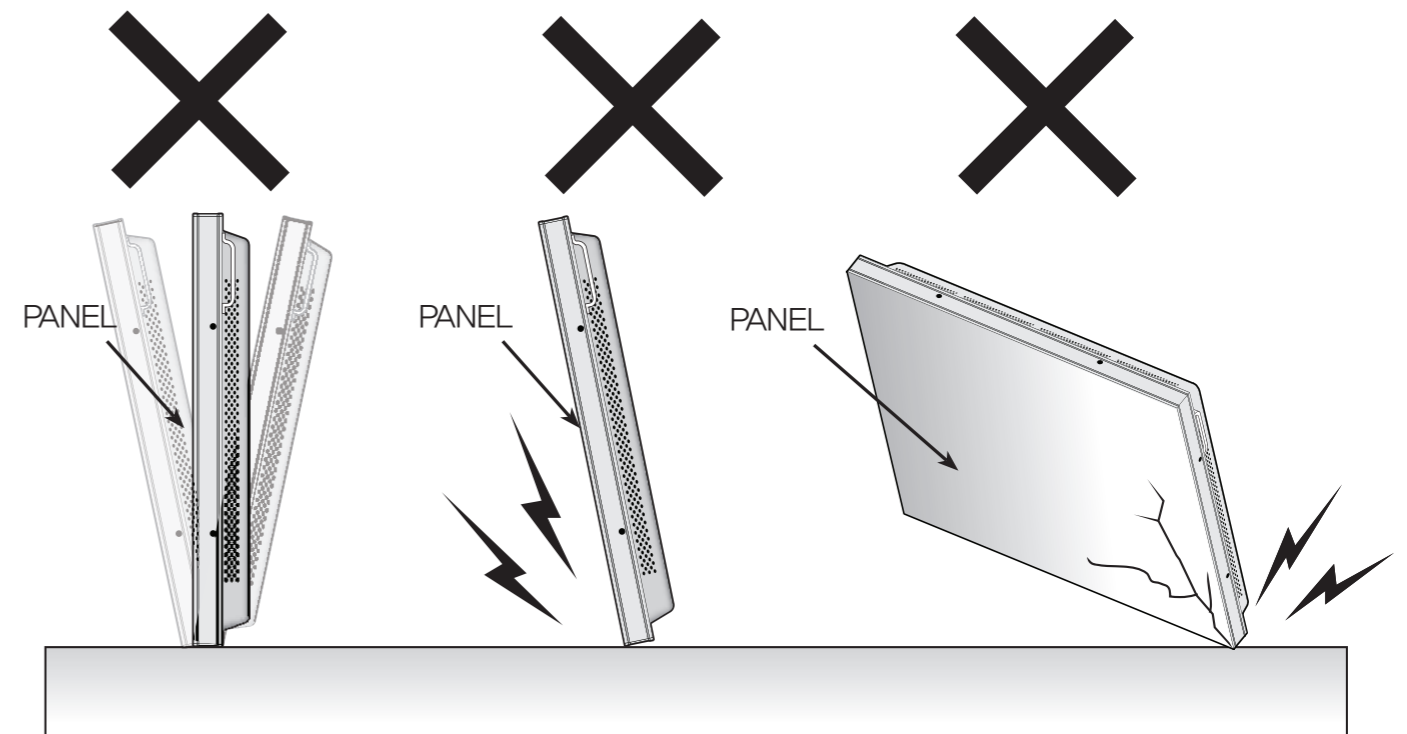

- Please do not stand PDP alone. It may fall or slip off and Panel can be broken or damaged.

- Please do not lean over the PDP. It may damage the bottom part of the PDP.

- Please do not lean over the PDP toward the edge part. It may damage the edge part of the PDP.

Open Structure

Unlike consumer PDP product, the panel of MPDP is exposed without any protective chassis. It needs extra caution to carry or install to prevent any impact.

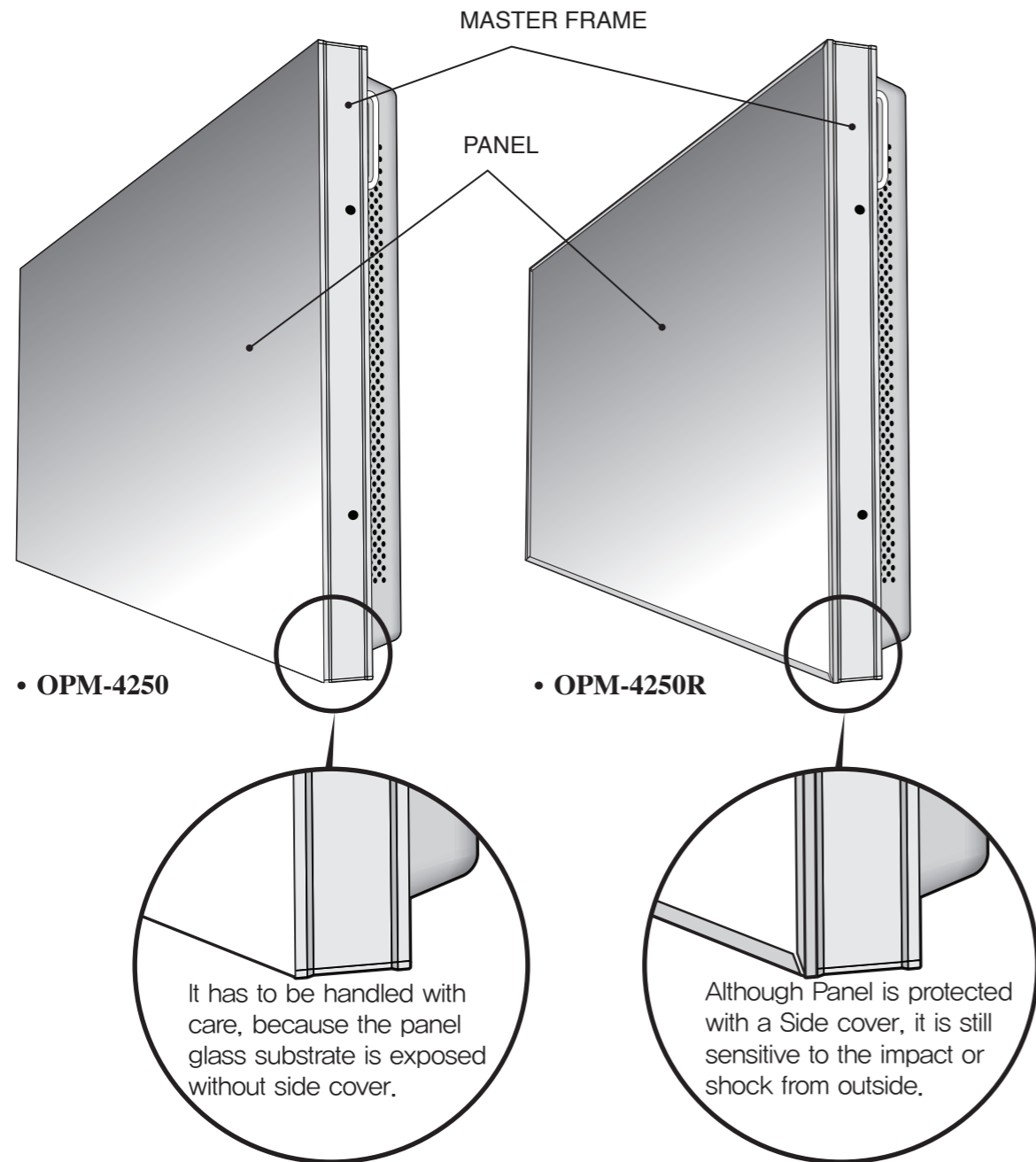

How to carry MPDP

Please see page 12 for unpack and handle assembly.

It always needs two persons to carry or install MPDP.

When you carry MPDP with up straight manner, please hold handles on the back and bottom part of the panel together.

Please be careful not to touch the bottom part of the panel when you put down the panel.

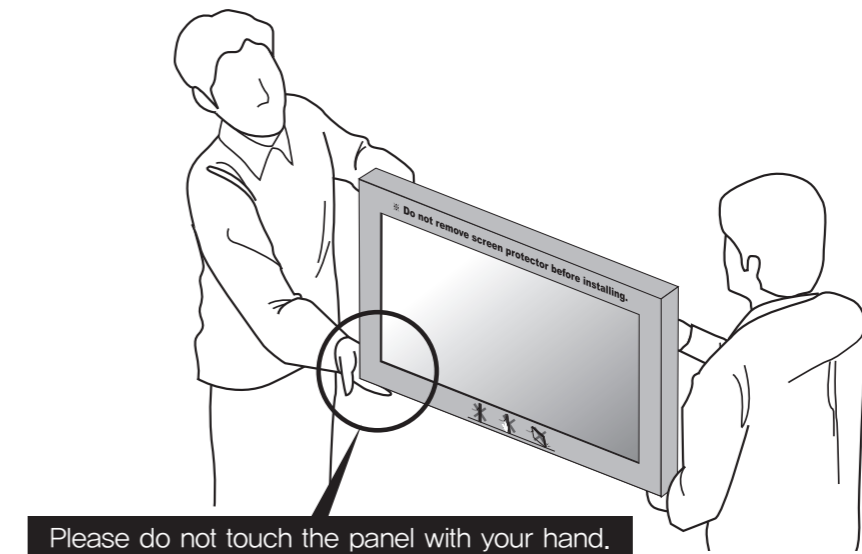

When you carry MPDP with flatbed manner, please hold handles on the back and lower part of the back.

Please be careful not to touch the bottom part of the panel when you put down the panel.

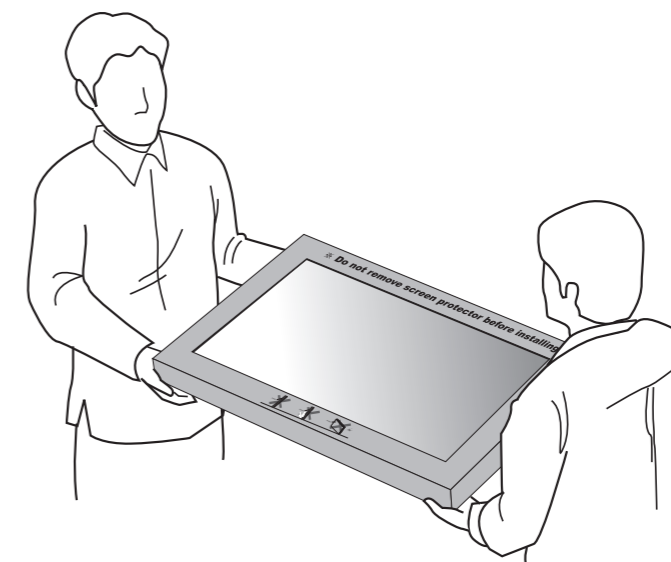

1. Safety Precautions

- If it operates abnormally, stop using it immediately.

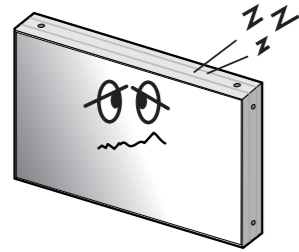

- Do not place any liquid-containing container on it. If the inside is wet, it may cause electric shock or fire.

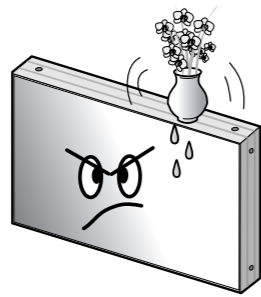

- Do not put any foreign material into the product. It may cause a failure or shorten the life span.

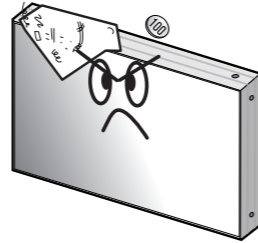

- Please refer to a specialized construction company for installing stand or wall mount unit. Otherwise, damage or injury may be caused.



- Do not touch the device when lightning strikes.

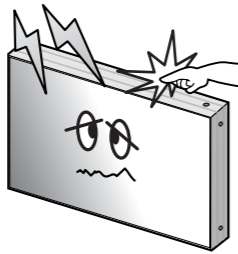

- Do not install in an unstable location. It may cause injury.

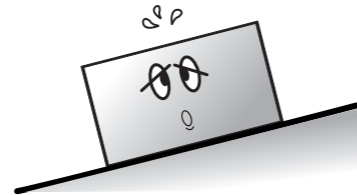

- Avoid any action to damage the power cord or power plug. It may cause fire or electric shock.

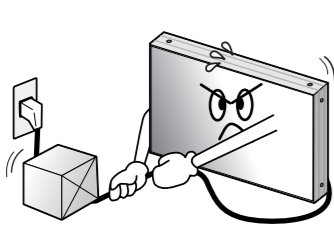

- Do not pull out the power plug with a wet hand. It may cause electric shock.



- Do not exceed ratings of AC outlet or extension cords. It may cause failure.

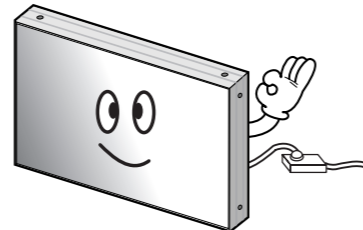

- Do not alter (or disassemble) the product. It may cause electric shock since high voltage is flowing inside.

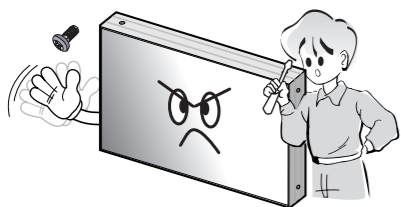

- Do not install the product where it may be exposed to direct sunlight or near any heating device. It may shorten the product's life span or cause failure.

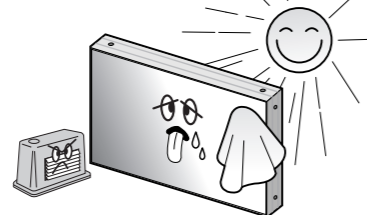

- Make sure the product is not covered with any object. If the ventilation hole is blocked, the inside temperature may rise to cause overheating resulting in fire.

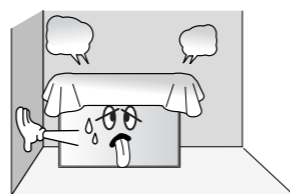

- Do not pull out or hang down the connection cable. It may damage the cord to cause fire or electric shock.

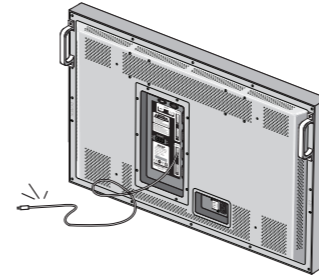

- Do not lean against the product or keep it leaned. It may cause injury or failure.

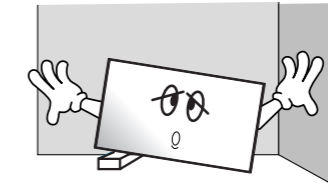

- Do not put it at any place with much humidity, dust, oil, smoke or steam. It may cause failure.

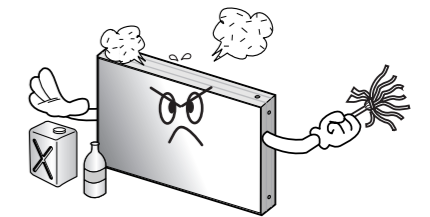

- Pull out the power plug by holding the plug. Otherwise, it may damage the power cord to cause fire or electric shock.

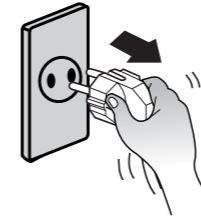

- If you do not want to use the product for a long time, keep the power plug unplugged to save electricity.
- The socket-outlet should be installed near the equipment and be easily accessible.

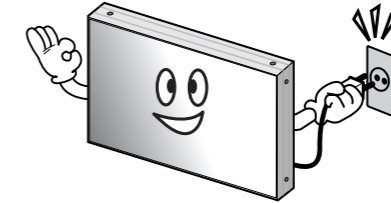

- Do not put any heavy object on it. It may cause failure.

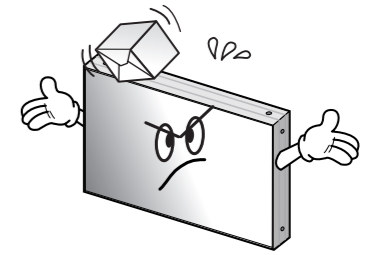

- Install the product on safe and flat surface.

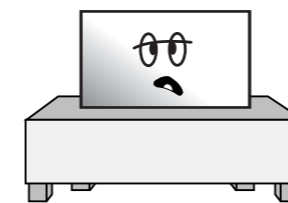

- Do not ride or step on the product. It may cause breakage when fallen down.

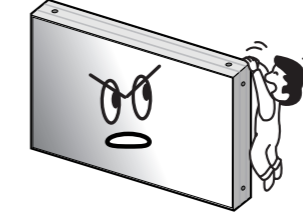

- When moving it, disconnect the connecting cable. Otherwise, it may damage the cable to cause fire or electric shock.

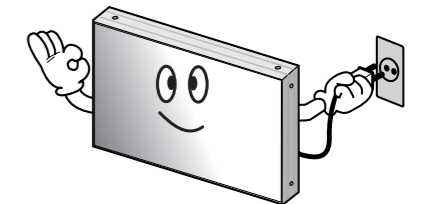

- Do not put candles on the product. If the liquid flows inside the product. It may cause electric shock or fire.

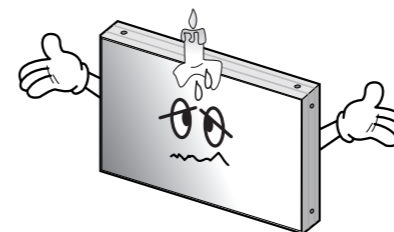

- Do not touch product's front surface with hand. Otherwise, the image quality can be lowered.

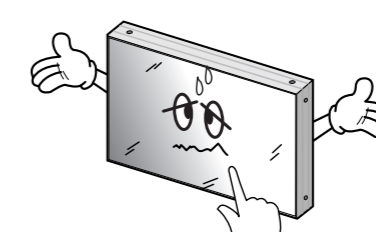

- Do not poke the front screen with sharp material. It may damage the screen and may cause malfunction of the product.

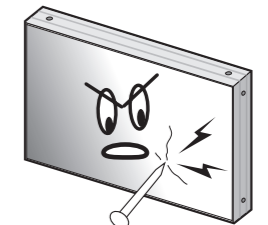

2. How to Install

- Install this set only at a location where adequate ventilation is available.

How to assemble handles

1. Product is packed in a box as shown in Figure 1.
2. Please carefully remove the Packing Bag with a knife or a pair of scissors.
 ※ Please check front and rear side before you cut the bag to prevent any damages on panel or set.

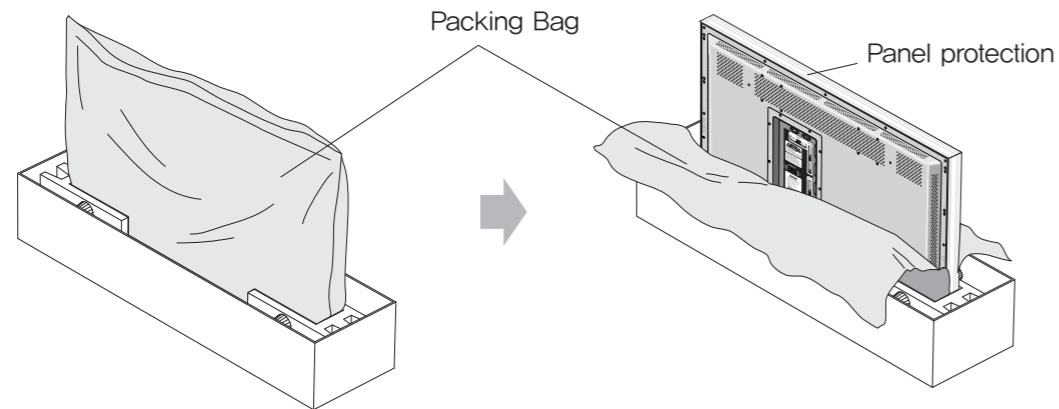

[Figure 1]

[Figure 2]

3. Please assemble handles with the bolts that are in the accessory box to the rear side as shown in the figure.

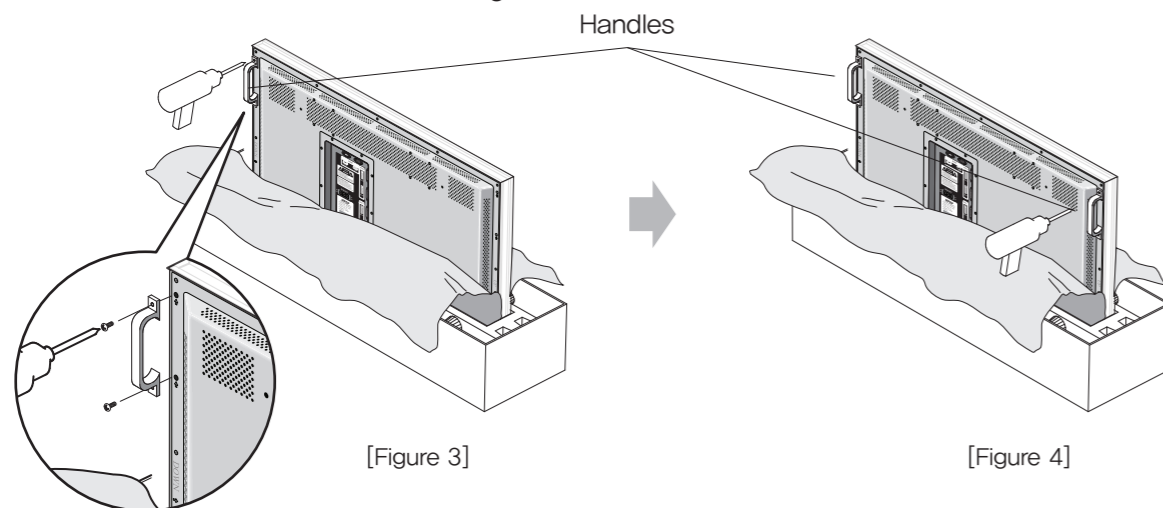

[Figure 3]

[Figure 4]

How to move MPDP

1. 2 people hold each handle on product's back side.

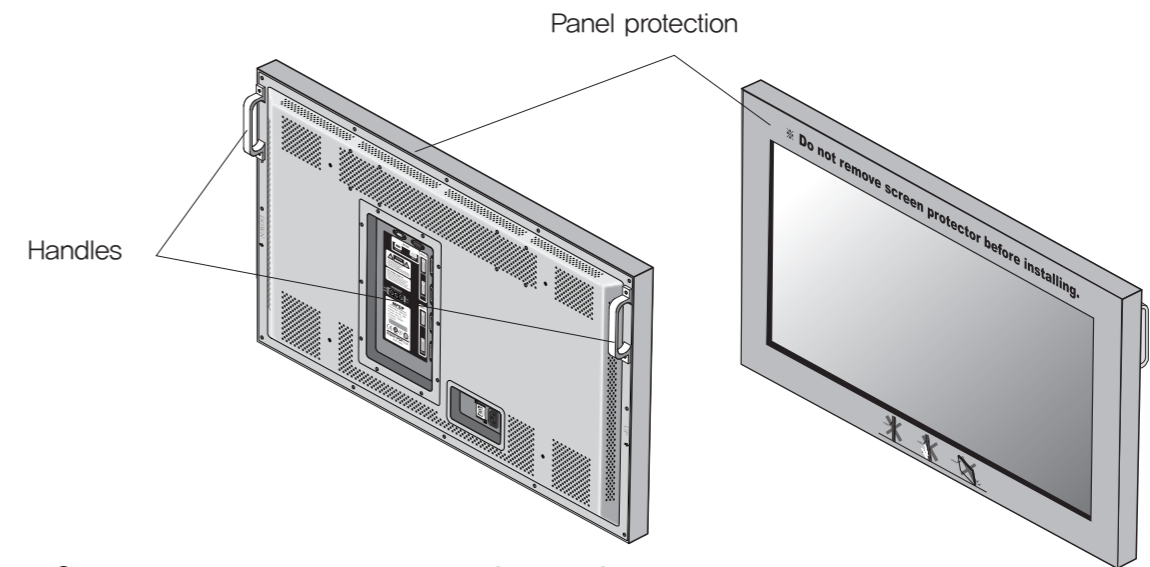

2. It needs two people to carry or install this product.

- Please hold the handles in the back and the front bottom part at the same time.
- Please do not grab the panel, but grab bottom of master frame when you carry or install the products.
 - Please use gloves when you carry or install the products.

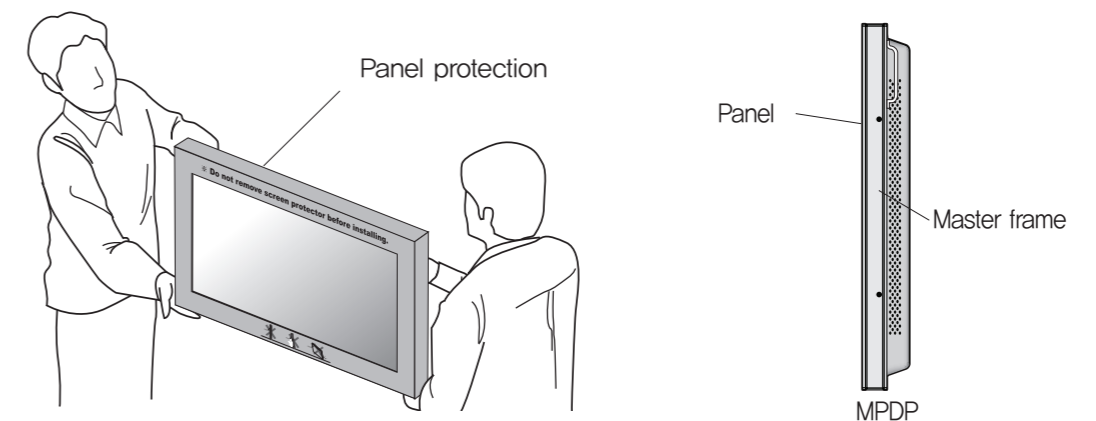

※ Attention :

- Do not remove the panel protection pad until a set is completely installed on a stand or a wall hanger. Please carefully remove Panel protection pad to prevent any damages on the product .
- Please make sure to use panel protection when you move, carry or rent MPDP.

MAIN FRAME Stand Unit (Option)

- Please do not install our product at following locations to protect the product and prevent possible malfunction.
 - Places of vibration or shock: PDP set may fall and damaged
 - Next or near to Sprinkler sensors: The sensors may detect heat from a set and sprinkler can be activated.
 - Around high voltage power lines: Noise from the power line may affect screen images
 - Around heating apparatus: PDP set may be overheated and damaged.
- The set can be installed as shown below.
(For further information, refer to the optional 'MAIN FRAME Installation and Setup Guide'.)

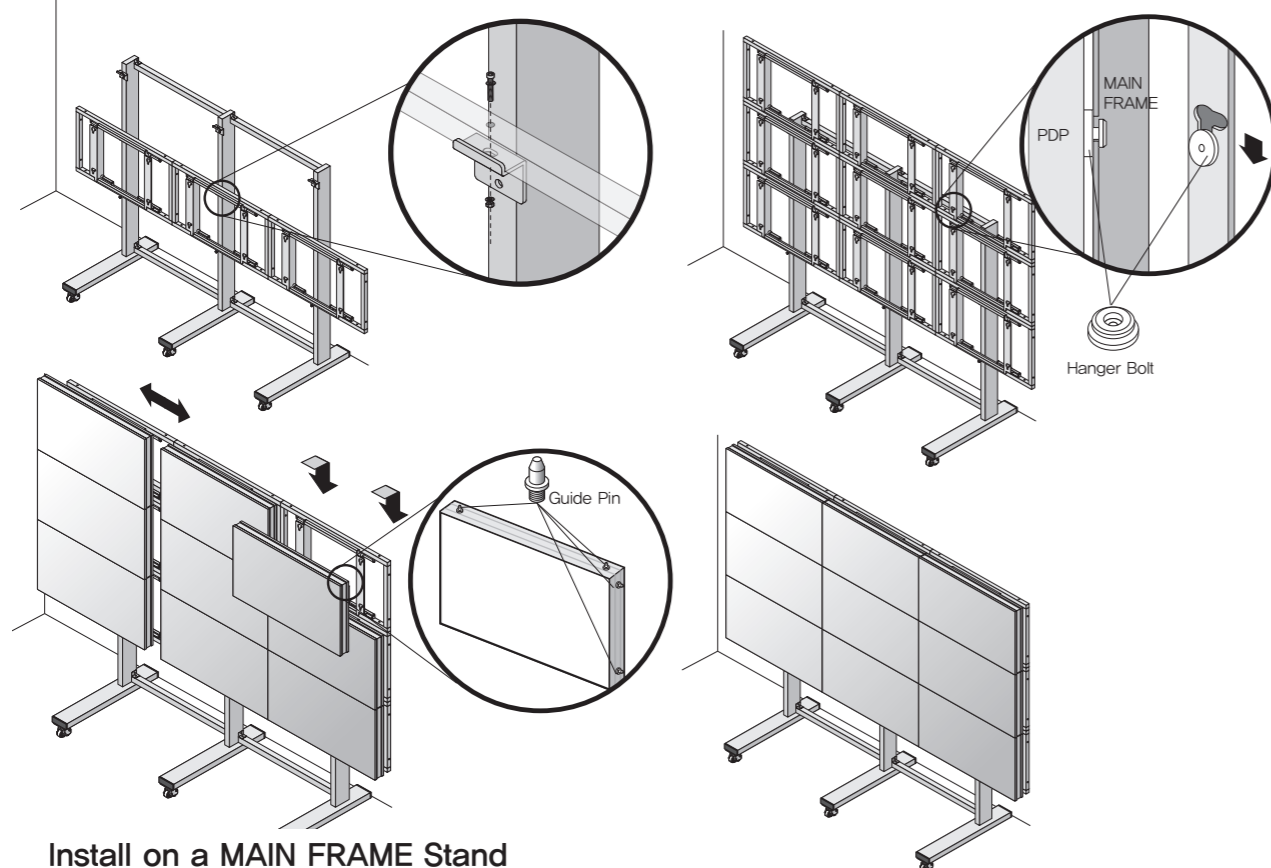

Install on a MAIN FRAME Stand

Please secure minimum clearance as shown in the picture for adequate ventilation and technical service.

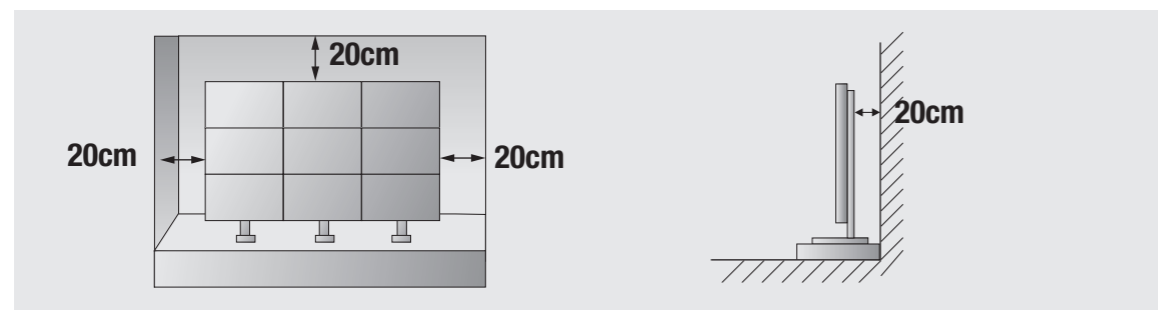

MAIN FRAME Wall Mounting Unit (Option)

- Please check the stability of wall.
If the wall is not strong enough, reinforce the wall before installation.
- Please connect all the cables to proper ports in a set before installation.
- The set can be installed on the wall as shown below.
(For further information, refer to the optional 'MAIN FRAME Installation and Setup Guide'.)

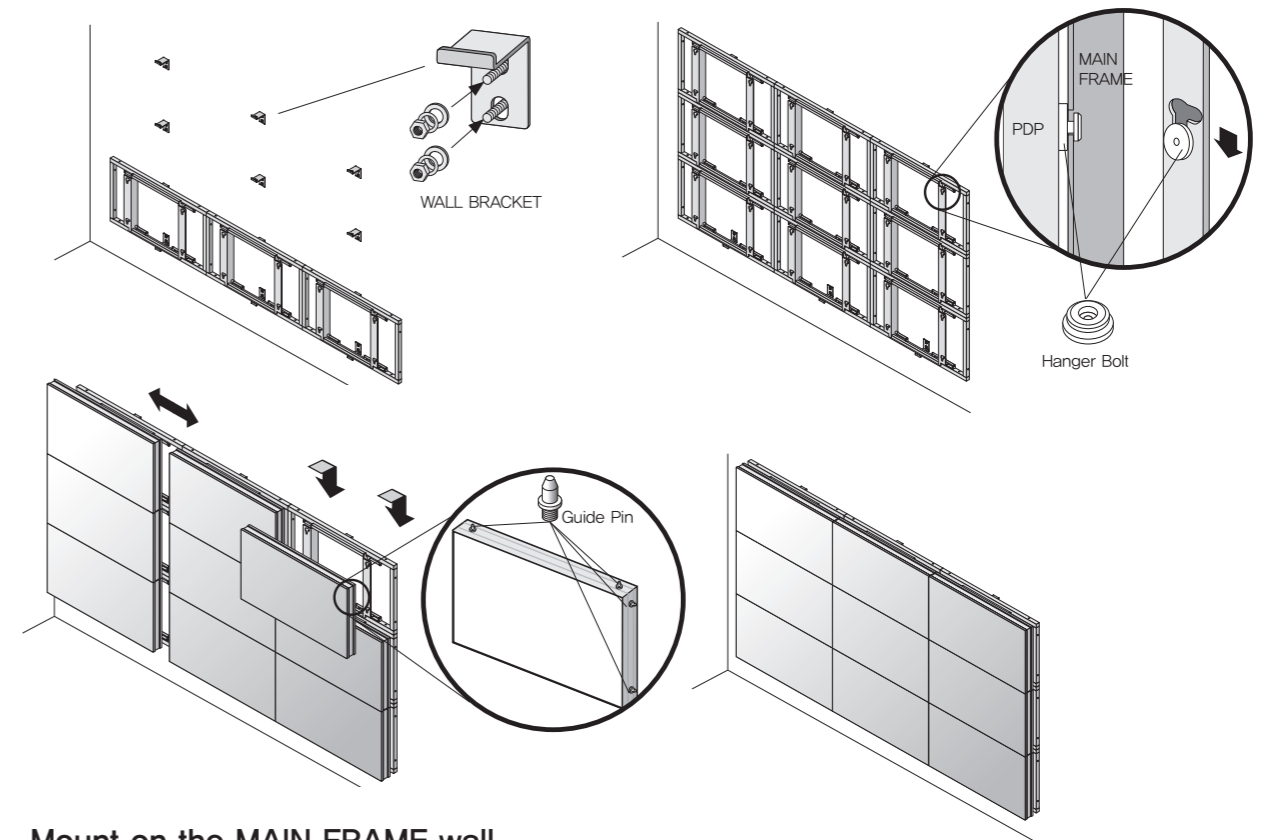

Mount on the MAIN FRAME wall

Please secure minimum clearance as shown in the picture for adequate ventilation and technical service.

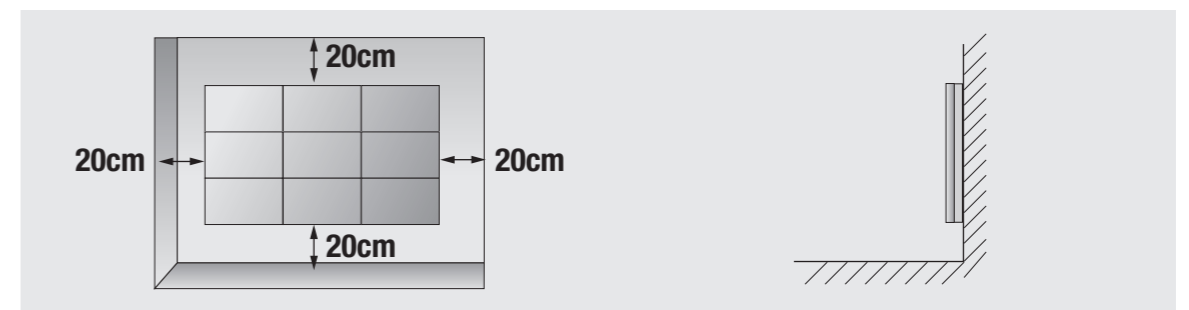

4. How to Connect Cables

4.1. Connection of one set MPDP

PC & DVI Connection

- MPDP and PC should be connected; a Com Port in a PC and RS-232C IN port in a MPDP is connected with supplied RS-232C cable.
- MPDP On/Off or Screen adjustment can be controlled by MSCS (Multi-Screen Control System).
- ID setting on the backside of MPDP must be identical with the ID setting in MSCS to control MPDP with a PC.
- If you do not have Com Port, you need to use an USB converter for RS-232C. Depending on manufacturers or models, converters may cause malfunction.

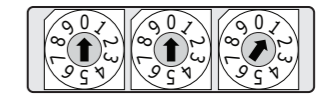
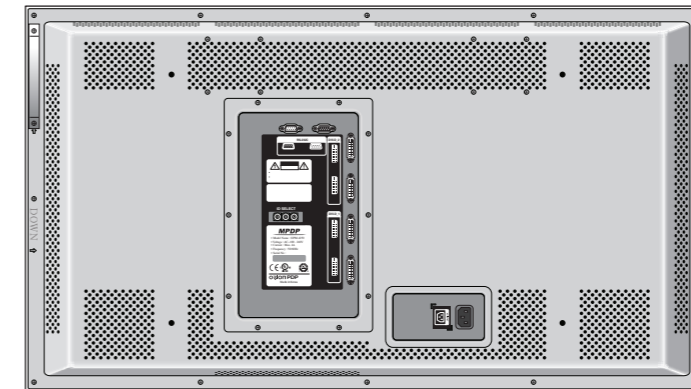
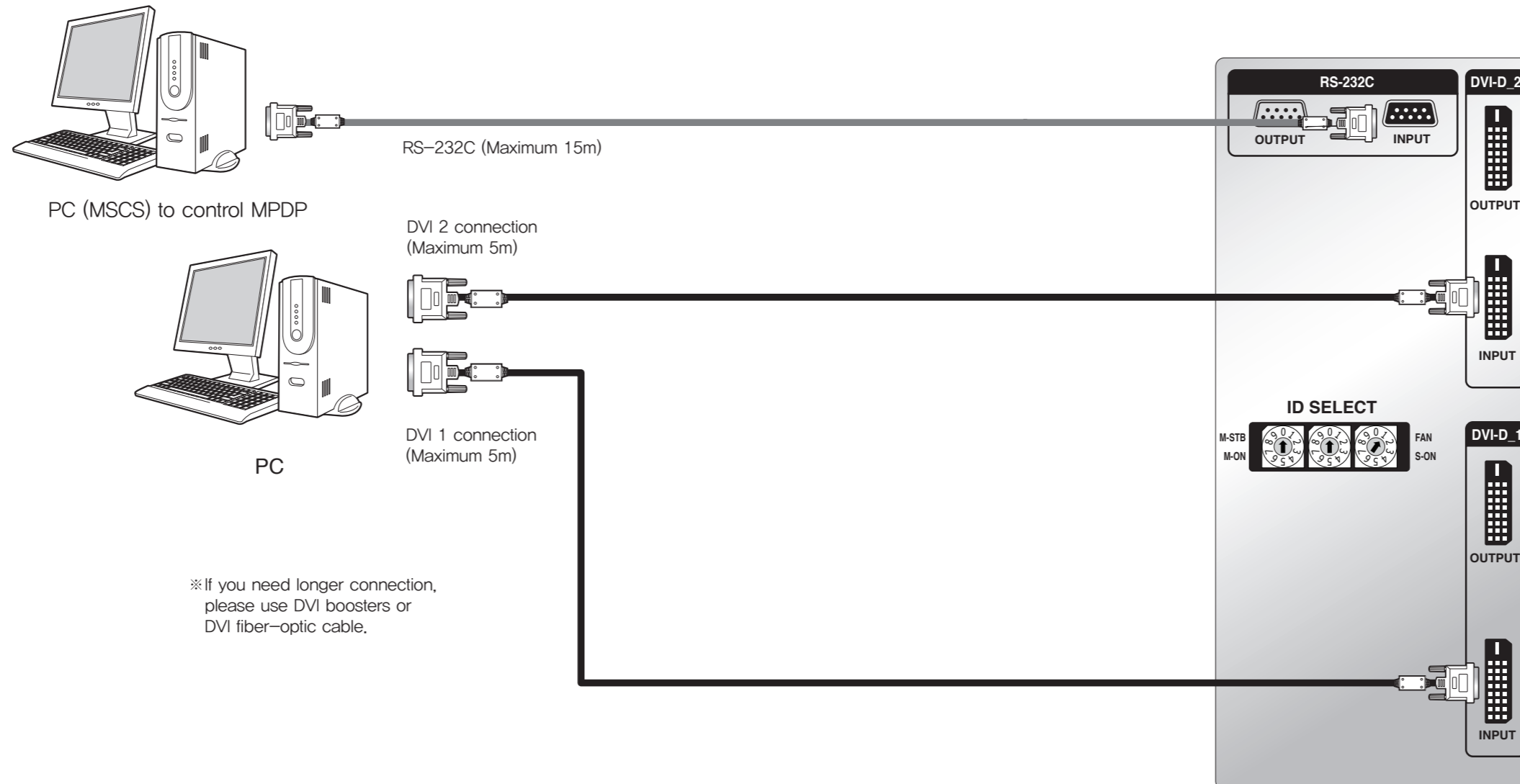

[PDP ID 1]

- ID switch must be set as ID 1 for one set use.

4.2. Connection of Multi-screen MPDP

- Recommended maximum set connection for Multi setting is shown in table below. If you need to connect more than described in the table, you have to use distributors.
- Image quality can be affected by cable or signal quality.

INPUT SOURCE	Resolution	Connection	Remark
DVI	1600 x 1200 x 60HZ	6 sets	80 page
RS-232C		30 sets	ORION Cable Only

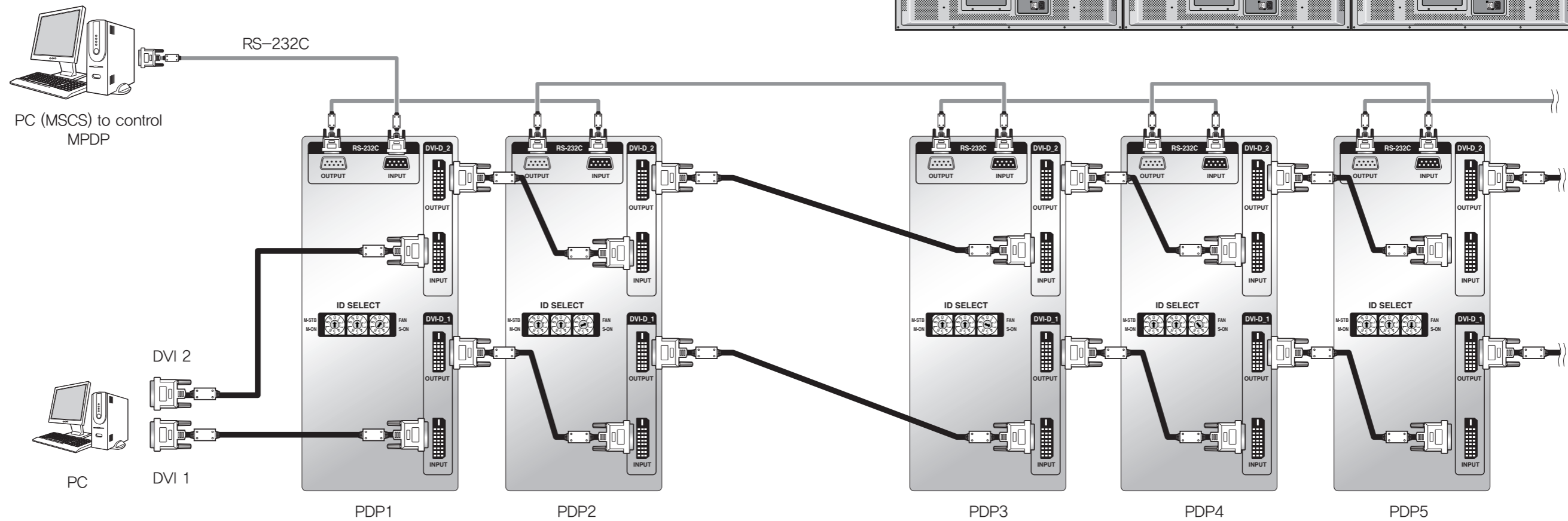
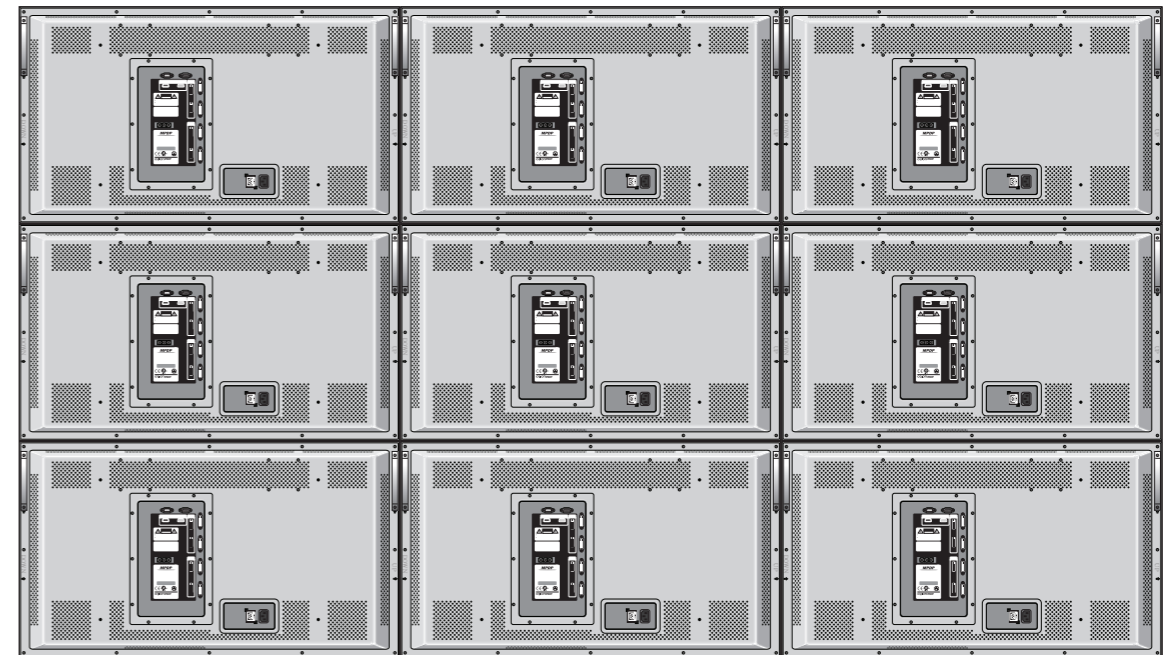

4.3. Connection of RS-232C Cable

- Maximum use of RS-232C with Daisy Chain connection is **30** or less.
If you need additional connection, use RS-232C distributor.

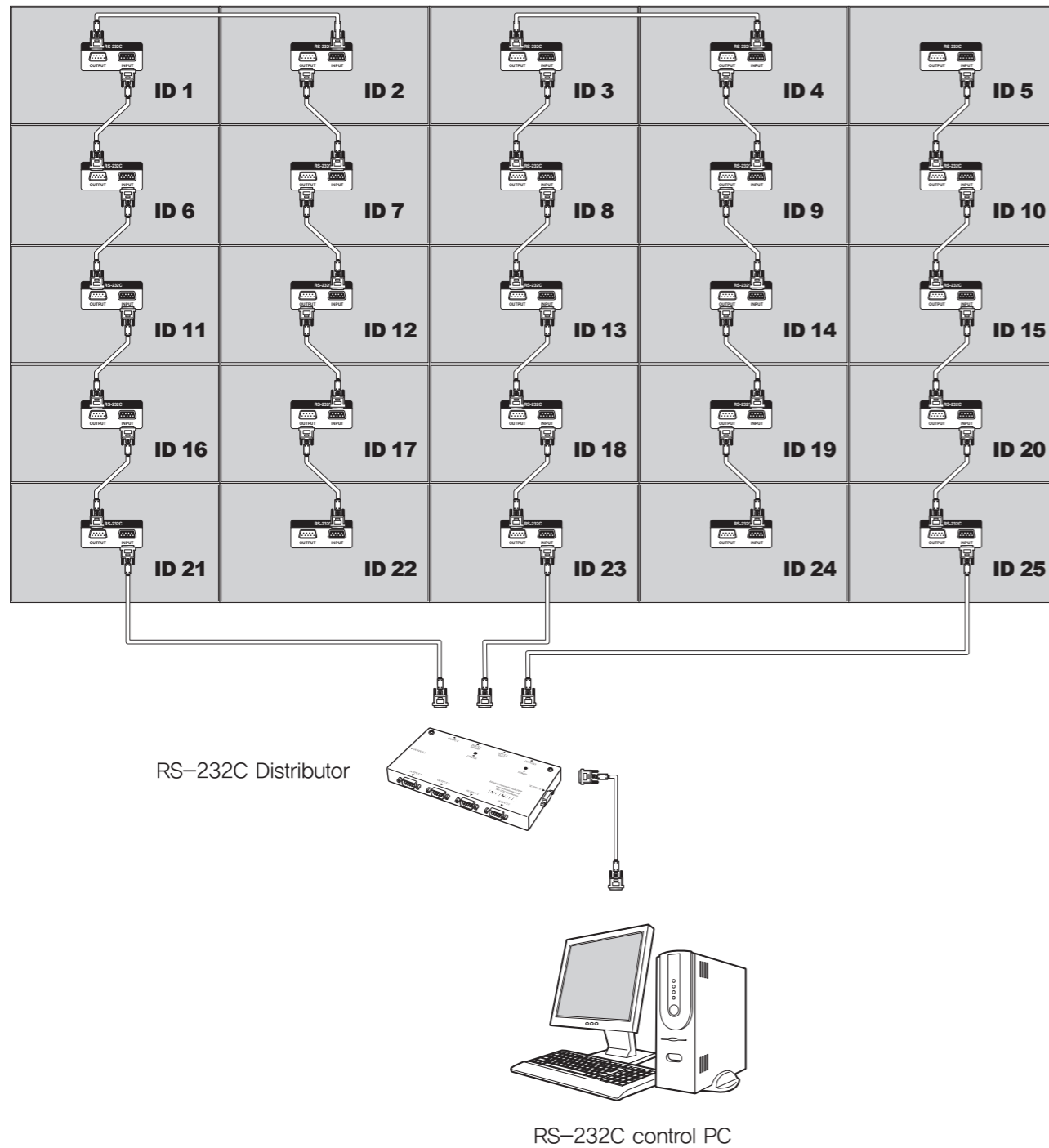

4.4. Connection of 3 x 3 MPDP

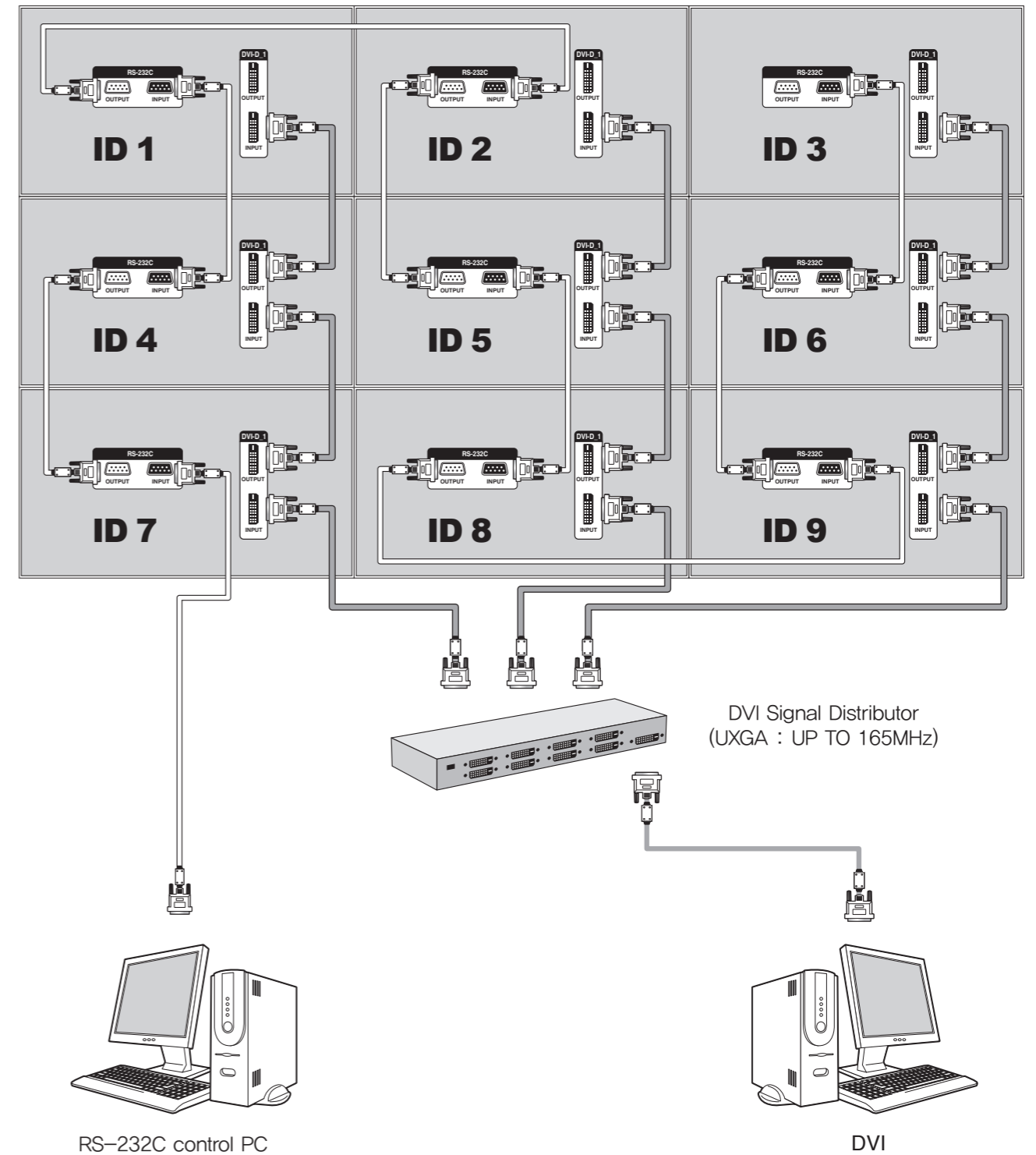

4.5. DVI Connection

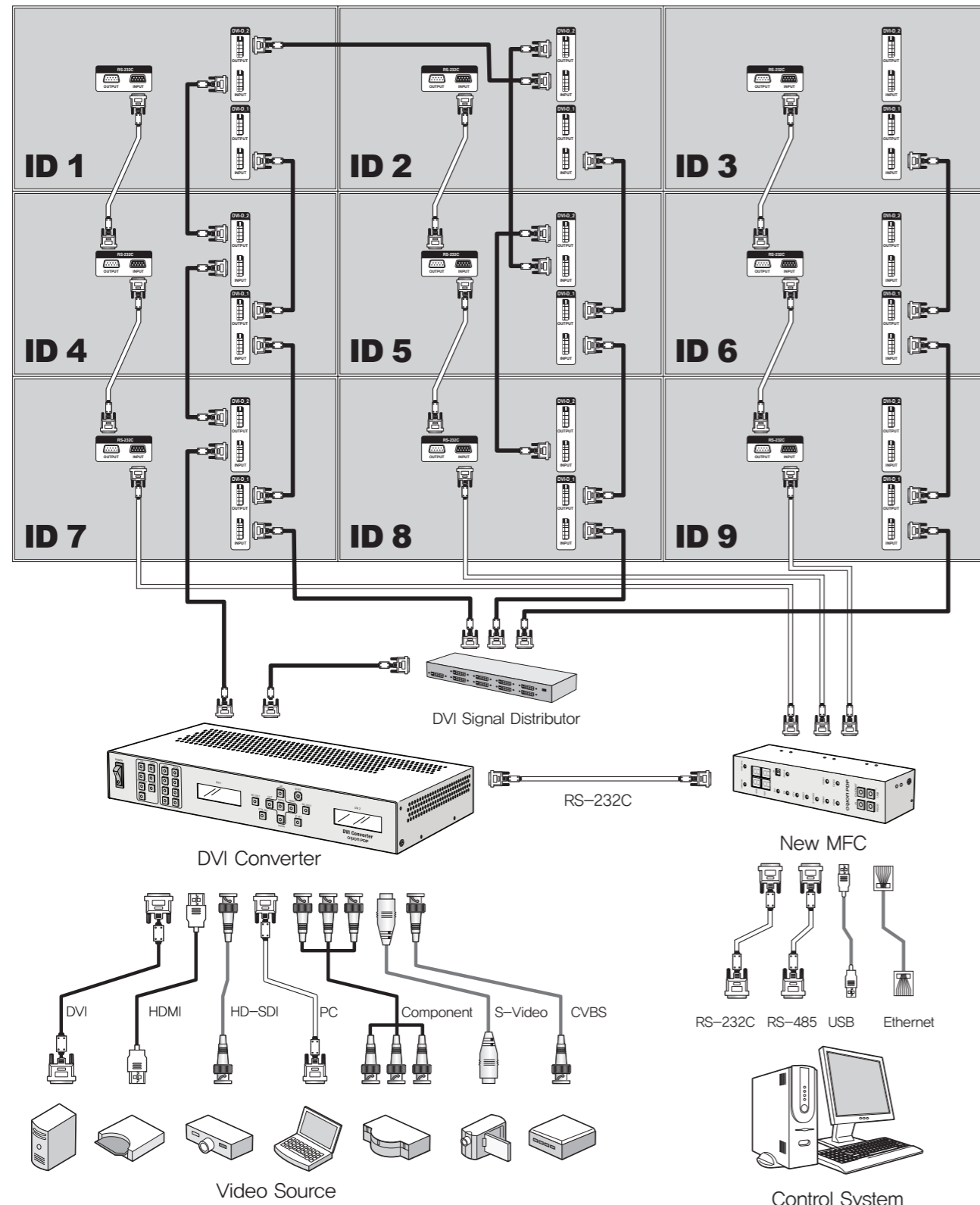

4.6. ID setting of X x Y MPDP

- Identity number (ID) indicates the location of each MPDP.
- When you look at the MPDP screens in front of MPDP,

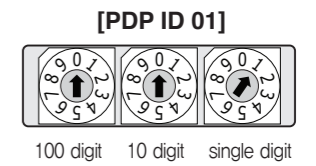

PDP ID 1	PDP ID 2	PDP ID 3	PDP ID 4	PDP ID 5
PDP ID 6	PDP ID 7	PDP ID 8	PDP ID 9	PDP ID 10
PDP ID 11	PDP ID 12	PDP ID 13	PDP ID 14	PDP ID 15
PDP ID 16	PDP ID 17	PDP ID 18	PDP ID 19	PDP ID 20
PDP ID 21	PDP ID 22	PDP ID 23	PDP ID 24	PDP ID 25

Recommended ID of X x Y screens

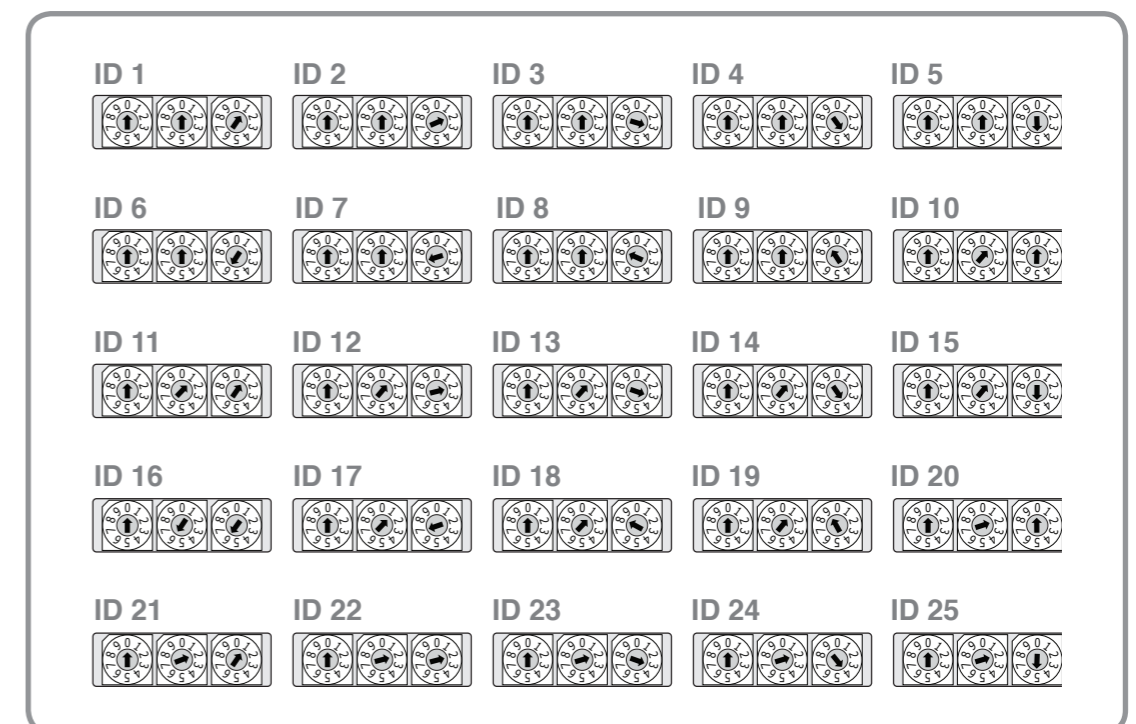

5. Setting and operation of MSCS software

5.1. MSCS Installation

- Insert the Installation CD.
- You can see following installation start screen.
- Select proper version for your product and start installation

• MSCS supports Windows® 2000, Windows® XP and Windows Vista™ only



MSCS Installation start screen.



Caution

Caution for using MSCS

1. Data for Picture control, Manual Tracking and so forth can be read by clicking the right button of your mouse on the desired MPDP set from MSCS.
Please do not use above function together with the other functions.
2. When you off AC power, execute power off by MSCS first and disconnect AC power to save your configuration.

5.2. Start MSCS

- MSCS is an application program needed to control MPDP.
- When you execute MSCS (v 5.0) for your product at the installation screen, it will create a new folder at *C:/Program File/MSCS (v5.0)* and an icon on your computer screen.
- By double clicking the MSCS (v 5.0) icon, the initial screen image of MSCS (v 5.0) will be displayed as shown in the picture.



Main Image of MSCS (Multi Screen Control system)

5.3. Setting 'Com Port'

- Com Port connects or disconnects the communication between PC and MPDP.
- Connect MPDP to PC Com Port via RS-232C cable.

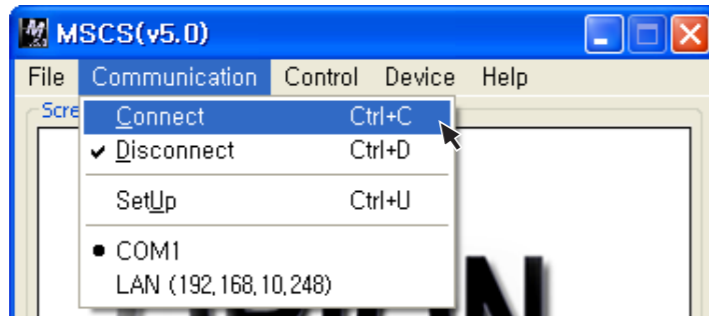

- Go to MSCS Menu → Communication and set Com Port. Click 'Connect' using mouse or press 'Ctrl+C' using keyboard.
- In order to disconnect communication, click 'Disconnect' using mouse or press 'Ctrl+D' using keyboard.
- When you use USB-to-RS-232C converters, you need to set Com Port again, because MSCS uses one of Com Port no. 1 to 30.

5.4. Port Setting

- MPDPConfigure the communication (Serial or Socket (Ethernet))
- Please select "Menu → Communication → Setup" or "Ctrl+U" to start Setup.

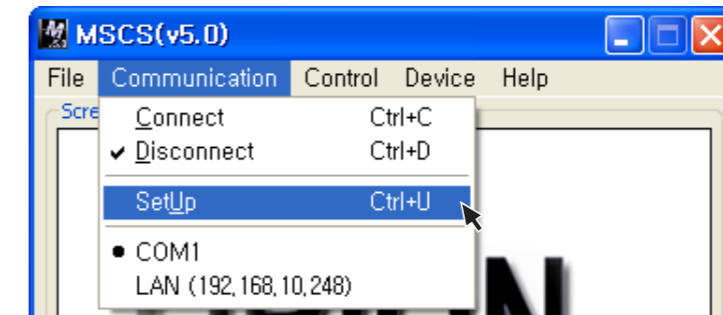

- **Serial** : Set the serial communication as a default communication.
- **Com Port** : Set the port of a PC to communicate with MPDP.
- **Baud Rate** : Fixed at 115200bps.
 ※ **Caution: Users cannot change the Baud rate.**
- **Socket** : Set the Ethernet LAN communication.
- **Edit Box** : Set the IP address.
- **Port Number** : Fixed as 9761.
 ※ **Caution: Users cannot change the port number.**
- **Ping Test**: Test the IP address.
- **Connect** : Connect the communication.
- **LAN** : Set the Ethernet communication.

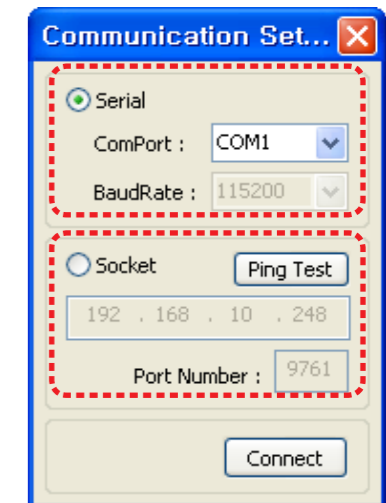

Communication Setup

5.5. "New design/Last design" setting

- When Com Port is successfully connected, pop-up window for "New design/Last design" appears.



New/Last Design Set

- Click "Open New Design" to prepare new configuration.
 - Click "Open Last Design" to go to last design before closing.
-
- When the connection is successfully completed after setting Com Port, following Message dialog is displayed. The dialog window will be disappeared in 1 second.

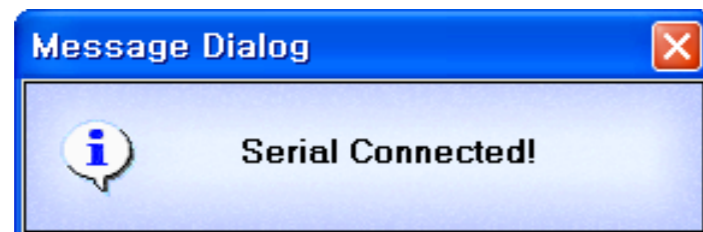

5.6. Multi-screen configuration

1 Input the numbers of X and Y

- X is for the number of row and Y is for column.
- X and Y can be selected within the range from 1 to 15. The maximum MPDP quantity of MSCS control is 100 sets.
- MPDP image of selected numbers of X and Y is displayed in the Screen configuration in one second after setting the number.

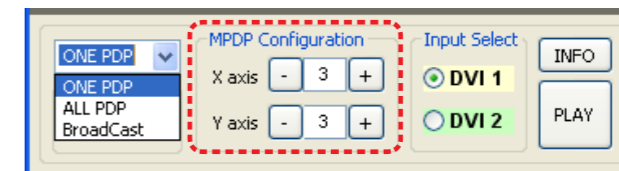

Screen Configuration Setting

2 Select one of input sources from DVI 1 or DVI 2.

3 Execution of the configuration.

- When you click "PLAY" button after selecting input source from Source select and the numbers of X and Y in MPDP Configuration, the configuration of MPDP is generated as shown in the figure below.

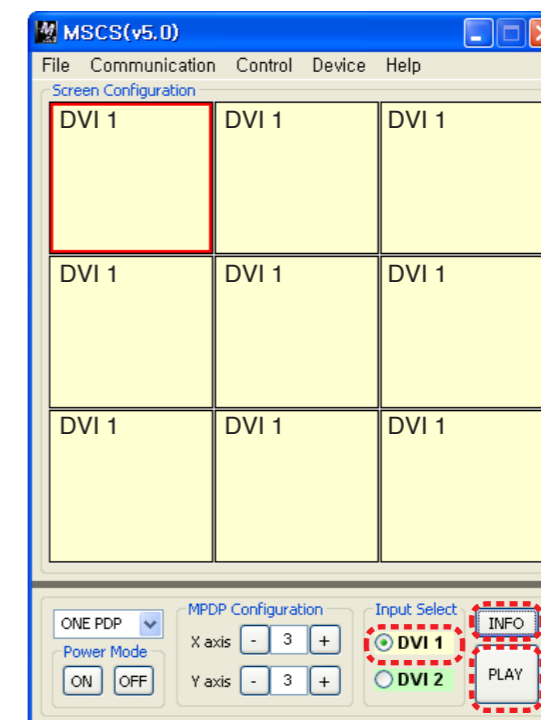

※ INFO :

- Check the resolution of the input source. It is displayed at the upper right corner of the screen.
- Check the signal. If there is no input signal, "No signal" is displayed.

5.7. MSCS Instruction

- Check "ALL PDP" to send data to all connected MPDP regardless of ID.
- **ONE PDP** : Transmit Protocol Command to one MPDP.
- **ALL PDP** : Transmit the Protocol command sequentially to all connected MPDP sets.
- **Broadcast** : Transmit the Protocol command simultaneously to all connected MPDP sets.
- In order to control power of specific MPDP, use "Power On/Off" button after selecting the specific MPDP.



MPDP Control – Power On/Off

Caution Please wait for at least 10 seconds before executing "Power On" command after the first AC power connection. If not, it may cause abnormal behavior. Please disconnect AC power and reconnect in case of abnormal behavior.

5.8. ID Setting

- ID of MSCS(Multi Screen Control System) is set automatically.
- To send a command to the desired MPDP set, select ID of the MPDP from Screen Configuration.
- Select ID using right button of the mouse. Selected ID is displayed with red square box.

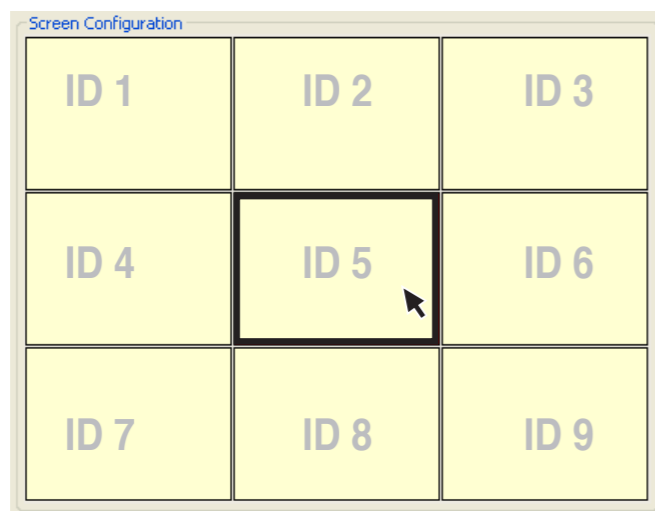

Example of MPDP ID Setting
(Input signal is DVI, Configuration is 3 by 3)

5.9. Input Select

- Varieties of screen formations are available with Input select configuration.
- Select DVI 1 or DVI 2 at the Input Select menu.

1 If you select DVI 2 and click Play button at the Input Select menu, the input source will be changed from DVI 1 to DVI 2.
 – In case you do not select a screen and click Play, the input source for the all screen will be changed.

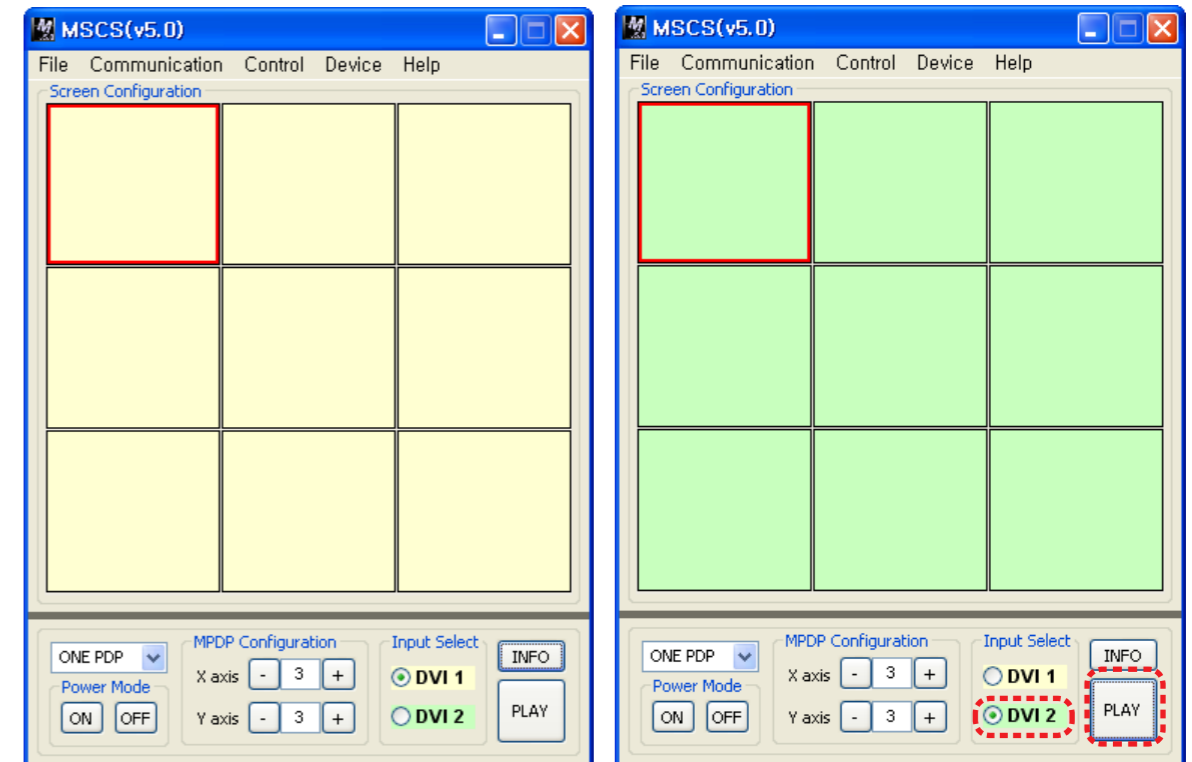

Select DVI 2 at the Input Select menu

※ Input source is not displayed on the MSCS screen, but it is indicated by colors.
(DVI 1: Yellow, DVI 2: Green)

1) Screen formation

- To make various Input–screen formation, select an input source (DVI 1 or DVI 2) and click the screen you want in the Screen configuration with the left button of the mouse.

1 Select DVI 2 at the Input Select menu.

– e.g.) in case DVI 2 is selected

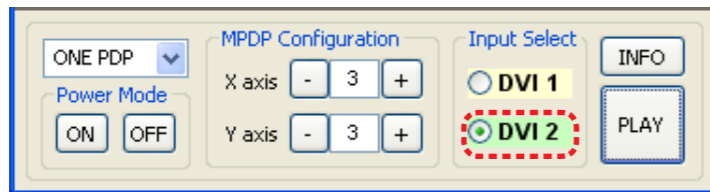

2 Click the screen you want in the Screen configuration with the left button of the mouse.

- Click the screen you want in the Screen configuration with the left button of the mouse.
- DVI 1 screen will be changed with DVI 2.

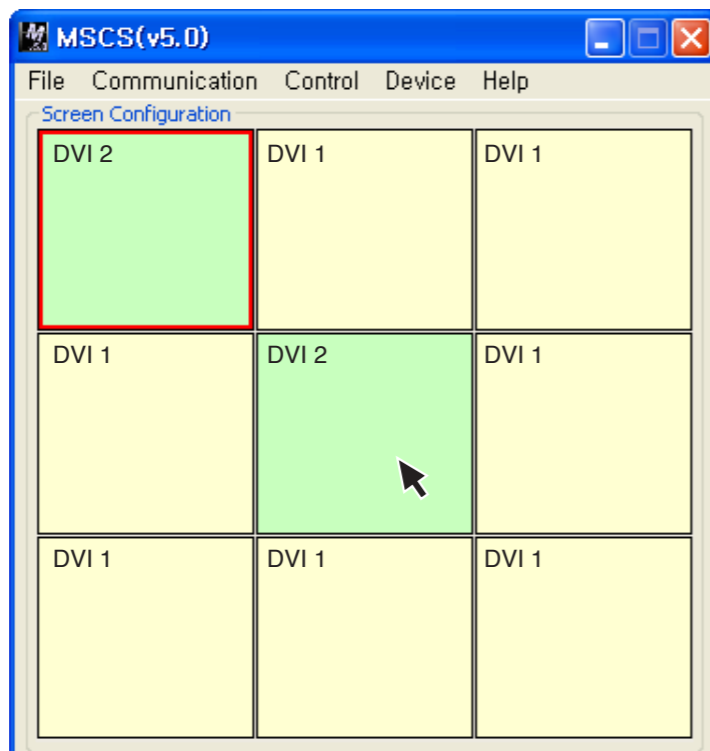

2) Screen Formation with one step.

- You can make various multi–screen formations with simple movement.

1 Select an input source at Source Select menu.

– e.g.) In case you want to select DVI 2

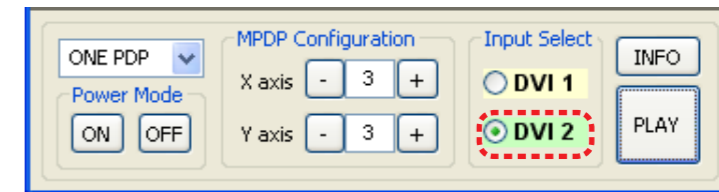

2 Click the screen you want in the Screen Configuration with the left button of the mouse and drag.

- Click the screen you want in the Screen Configuration with the left button of the mouse and drag to the screen you want to include.
- When you stop dragging, selected screens will be changed to DVI 2 automatically.

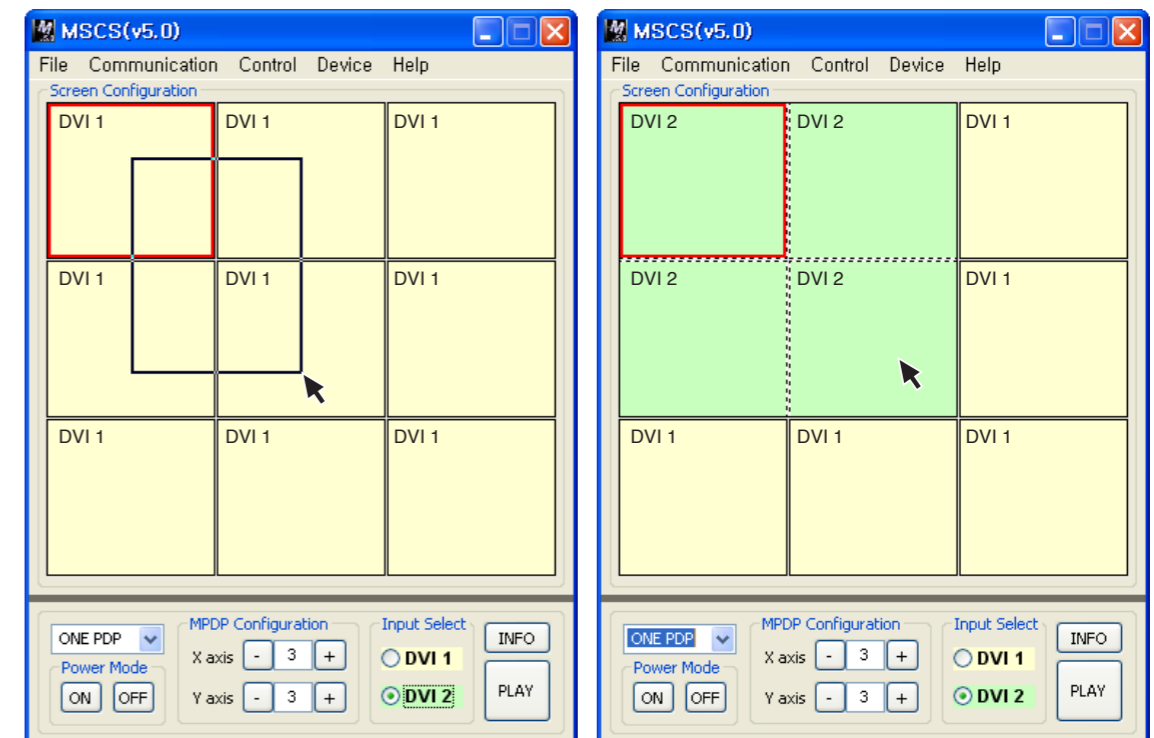

5.10. Slide Control

- MPDP configuration that users can choose is displayed repeatedly.
- To use Slide Control, go to MSCS Menu → Control → Slide Control or press "Ctrl+S" using Keyboard.

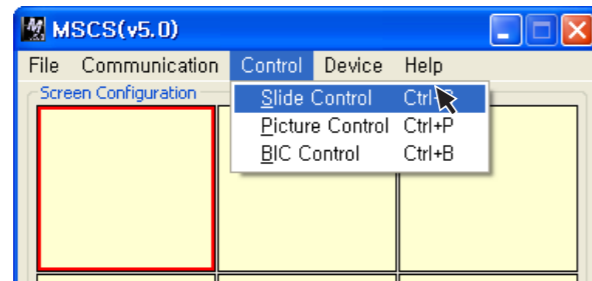

1 Make a desirable configuration in "Screen Configurations"

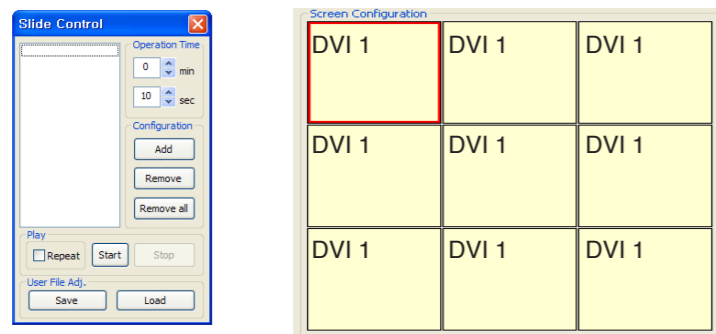

2 Set "Operation Time" in "Slide Control"

- Click "Add" button to save configuration.
- The range of "Operation Time" is from 10 seconds to 1 hour.

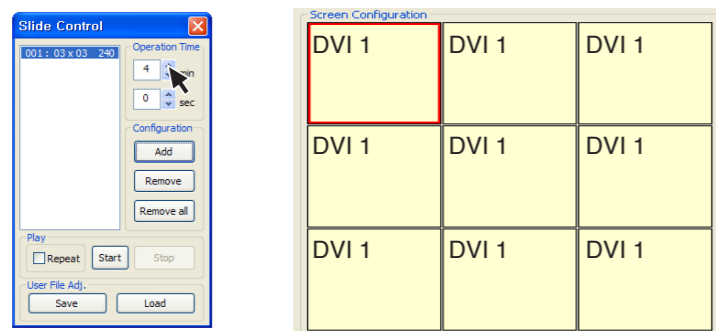

3 Save various screen configurations in the same way.

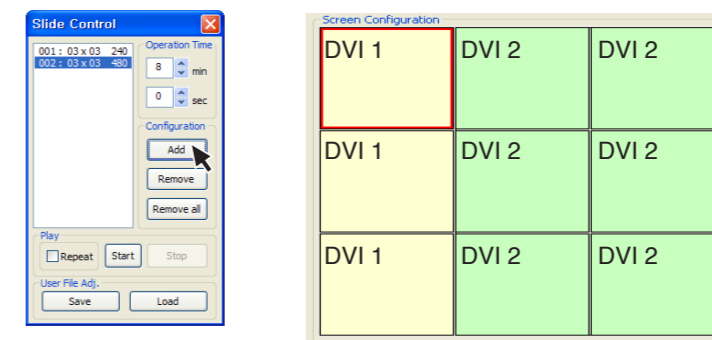

4 Click "Slide Start" to display saved screen configurations.

- Saved screen configurations are displaying for preset time.

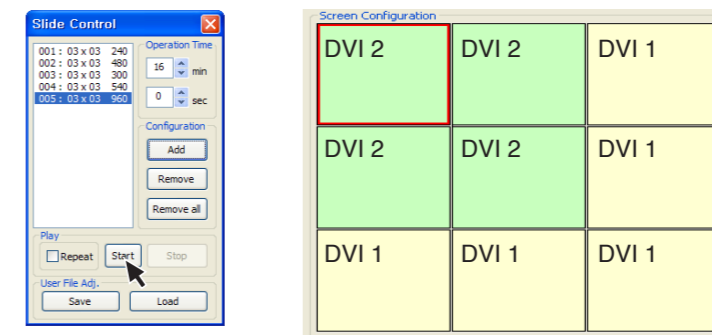

5 Check "Repeat" to display saved configuration repeatedly.

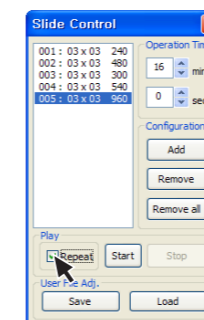

6 Click "Stop" button to end "Slide Control"

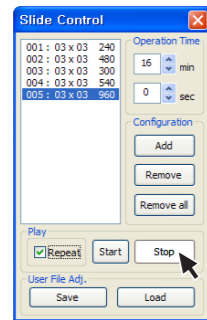

7 Save or Load the slide configuration

- Click "SAVE" button to save user added Slide configuration as "*.ssd" file.
- Click "LOAD" button to open saved "*.ssd" file.

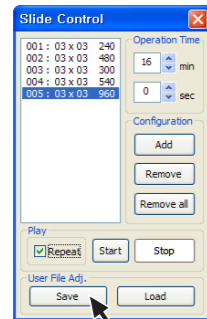

Caution When you load "Slide File", previous slide configuration and new slide configuration must be identical. If they are different, the file cannot be loaded. So, revise the new slide file configuration as previous configuration or save as new file.

※To view the saved screen configuration, select the list from "List Box."
 ※Saved screen protocol is transmitted to MPDP by double clicking the list.

5.11. Screen Control

- Register values related to display of MPDP can be changed.
- To use Picture Control, go to MSCS Menu → Control → Picture Control or press "Ctrl+P" using Keyboard.

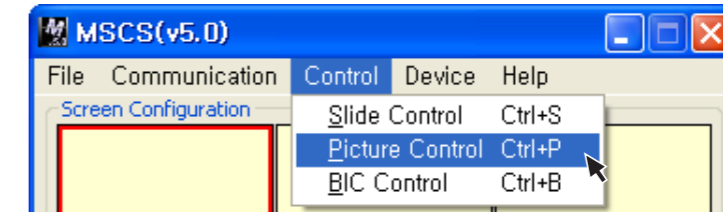

- In order to control display values, input values directly in "Edit Box" and press Enter key. Or click -/+ button using mouse.
- Click "Exit" button or press "Ctrl+X" using keyboard to close "Picture Control" window.
- **Color Temp** : Change the color temperature of the screen
 - Normal : Initial setting. Proper for normal video image view.
 - Studio : Low Color temperature. Proper for broadcasting purpose.
- **Brightness** : The range of "Brightness" you can adjust is 0 to 100.
- **Contrast** : The range of "Contrast" you can adjust is 0 to 100.
- **Sharpness** : The range of "Sharpness" you can adjust is 0 to 28.
- **User Data** : Users can adjust color impression with white screen and save or load the adjusted value.
 - Save - Save User' s data file (*.pdt)
 - Load - Load User' s data file (*.pdt)

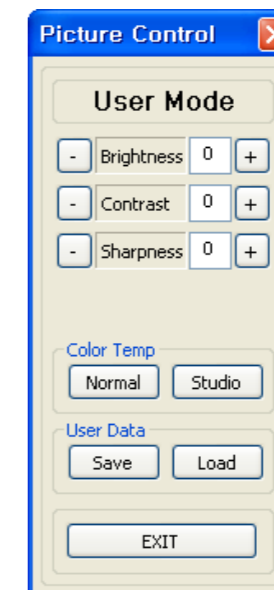

5.12. BIC Control

- You can control BIC functions related with burn-in compensation.
- Please select "Menu → Control → BIC Control" or "Ctrl+B" to start BIC control.

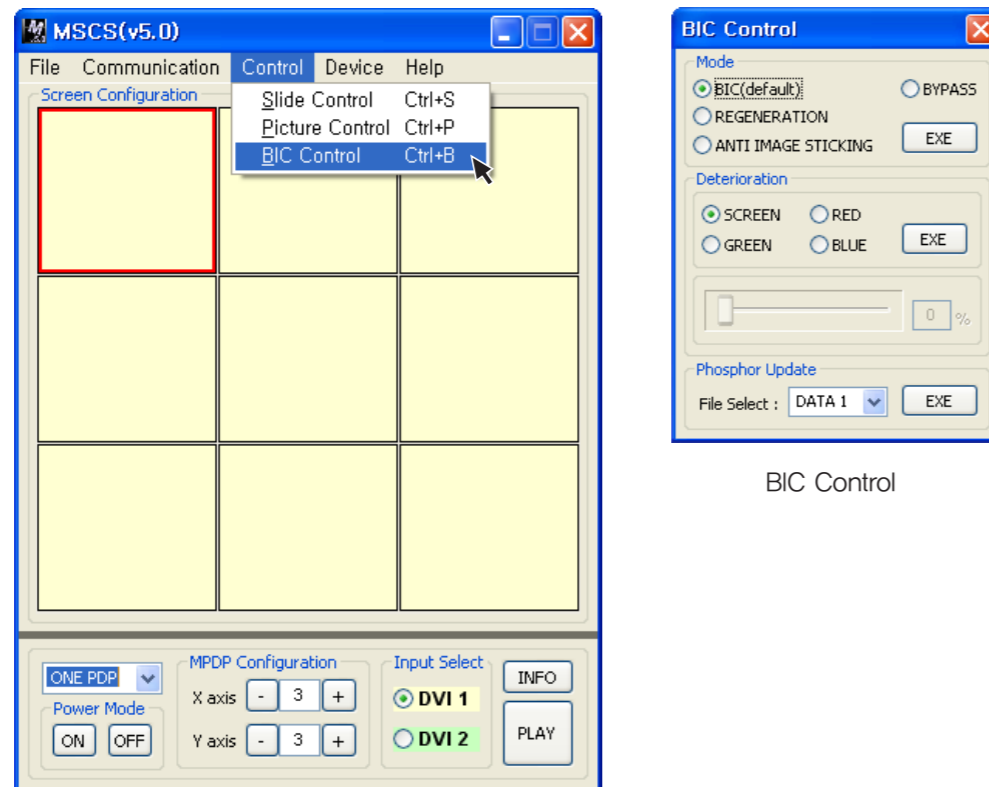

BIC Control

- Select one of BIC mode, BYPASS mode, REGENERATION mode and ANTI IMAGE STICKING mode and click "EXE" to control Burn-in compensation function.

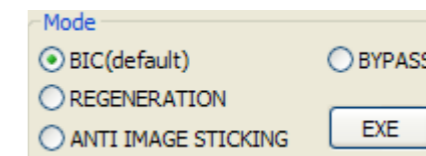

1. BIC On/Off

1) BIC Mode :

Activate BIC function to reduce burn-in effect. (BIC function On)

2) BYPASS Mode :

Deactivate BIC function, but BIC board keeps recording burn-in history.(BIC function Off)

2. Additional compensation

1) REGENERATION Mode :

Compensate burn-in effect by displaying a reversal image of the current burn-in image.

2) ANTI IMAGE STICKING Mode :

In case you find serious Burn-in effect in a certain area, select "Anti Image Sticking Mode," White Stripe pattern scans whole screen to make uniform screen condition to eliminate unequally burned pixels.

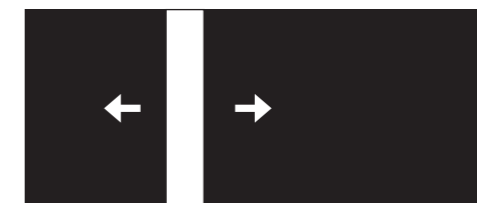

White bar pattern in the screen moves horizontally.

Precaution for Wall Controller device

* MVP devices can be used with APL off mode and it can be selected by MSCS control. When APL is turned off, brightness is slightly decreased.

MVP (Multi Video Processor) device?

It is a multi channel image processing system using digital signal processing methods. It converts analog composite videos to digital format, save in a memory and process the saved image data without any frame loss and image deterioration to communicate with a computer.

* For more information for APL, please contact with the dealers or agent where you purchased the MPDP.

- Phosphor Update function changes phosphor value.
If you cannot have satisfactory compensation result by adjusting Deterioration function, you can change phosphor value.

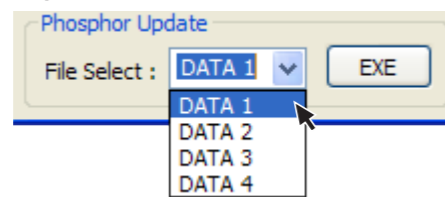

- Deterioration function adjusts deterioration range for Red, Green and Blue respectively.
 - Set up Test pattern—Red, Green, Blue and "SCREEN" external image source, to control Deterioration.
 - Adjust Deterioration range for Red, Green and Blue respectively.
Adjustable range is 70% to 130% and initial value is 100%.
In case surrounding pixels are brighter than burn-in image, increase the present value and surrounding pixels are darker, decrease the value.

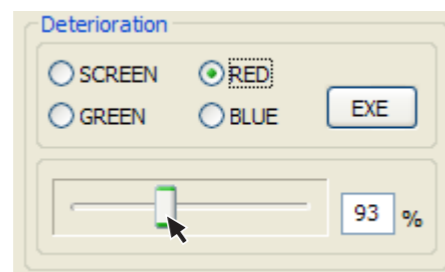

← Lower luminescence. Higher luminescence. →
Activation status between 70% ~ 130%

BIC status Indicator

- RED** : MALFUNCTION, A SMALL RED SQUARE CONTINUOUSLY BLINKS AT THE LOWER RIGHT CORNER OF THE SCREEN.
- Green** : Normal, a small green square blinks several times and disappears at the same position.
- Yellow** : BIC related events such as Update, a small yellow square continuously blinks at the same position.

Caution

- Screen may fade in and out when power on. It is a process of BIC initial update.
It is not a malfunction of MPDP.
- Do not use BIC function during moving images. (BYPASS MODE)
- Brightness can be decreased for burn-in compensation.

Burn-In-Compensation Control Method

- User can select a color (Red, Green or Blue) for compensation from Deterioration Menu in the BIC Control menu.
- When you find disturbing Burn-in effect on your screen, please select a proper value from Data 1, Data 2, Data 3 and Data 4 in the phosphor change option and execute. (It takes 1 ~2 seconds)
Please select Data 1 when Burn-in pattern is brighter than surrounding screen area and select Data 4 for darker Burn-in pattern than surrounding screen area
- If the selected value does not cause enough compensation result, repeat above process up to 4 times, and select the most satisfactory value and fix the value.
- If the compensation result is still not good enough, you can fine tune Red, Green and Blue colors one by one in Deterioration Menu
- Please control Green, Blue and Red sequentially.
Initial value is set as 100% and it can be controlled within the range of 70% ~ 130%.
- In case of Burn-in pattern is brighter than surrounding area, select lower value (under 100%) and higher value (over 100%) for darker Burn-in pattern.
(Please find optimal value through changing the value by 10 %)
- Sequentially control Red, Green, and Blue, examine the result with white pattern and repeat the process.
- If you do not have satisfactory result after repeating above process, please change the value of Green, Red and Blue by 1% until you can find the best result.
- In case, the compensation result is still unsatisfactory, REGENERATION Mode and ANTI IMAGE STICKING Mode may be applied for better result.
- Adjusting White Balance after BIC control process may improve compensation result.

BIC Intervals and effect

Burn-In-Compensation function is executed automatically. However, the level of burn-in effect may vary due to input sources and display period.

In case, you can notice disturbing level of visual burn-in effect, we recommend to execute additional compensation functions.

It is very effective to execute such compensation after 3months of daily 24hour use.

If you do compensation prior to 3 months, the compensation result may be less effective.

If you have any questions or need further information, please contact us or the dealers where you purchased the product.

How to Control BIC

1.MSCS

- 1) MSCS and MPDP must be always connected.
- 2) If MSCS command is executed prior to the BIC command, the BIC command will be executed again one hour later.
- 3) Turn off the energy save mode of the computer.
- 4) The compensation for undesirable burn-in effect is made automatically when BIC function is executed. If the compensation result is not satisfactory, use additional Burn-in compensation function in MSCS. (Please see page 41 for further information.)

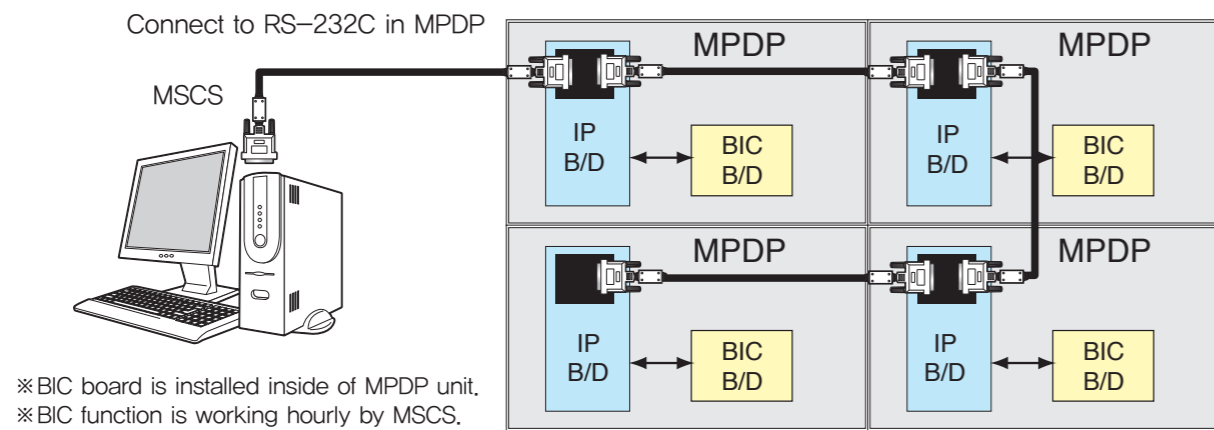

2.The other control program (besides MSCS)

Refer to BIC protocol and program guide to insert BIC control program into the MPDP control program.

3. In case you want to use New MFC without using MSCS

- 1) If you want to use the other MPDP control program besides MSCS and you cannot integrate BIC control program into the MPDP control program, you can use New MFC.
- 2) The numbers of MPDP units should be set by New MFC.
- 3) The New MFC connected to MPDP must be always turned on.
- 4) During BIC function is being executed, all the commands are ignored. Even the remote controller is not responding. If BIC command is given during the command from New MFC, the BIC command will be executed one hour later.
- 5) Please refer to the next page for "5.13. New MFC configuration".

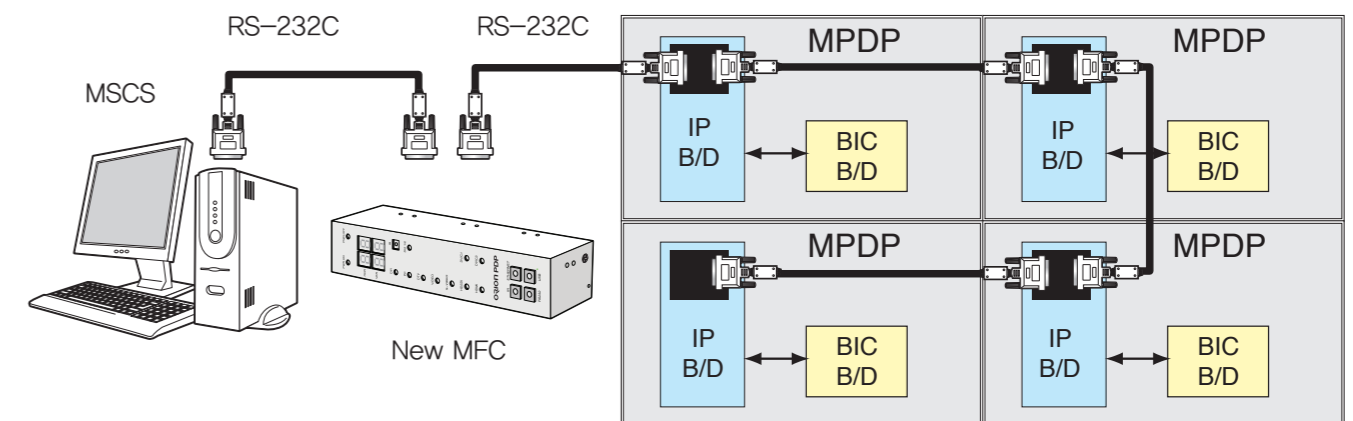

5.13. New MFC configuration method

1) New MFC Connection

1. Connect power.
2. Connect female D-sub to the Com port in a computer.
3. Connect male D-sub to the RS-232C port in MPDP.
4. Install the MFC connected with RS-232C cable and a power adapter at the location of good Remote controller reception.
5. Set the number of the connected MPDP units in advance. The number can be set only by the Remote controller.

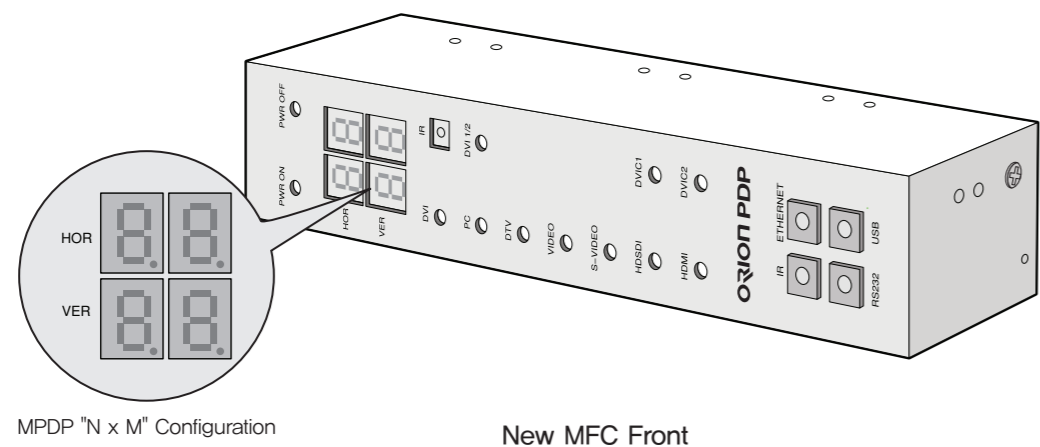

MPDP "N x M" Configuration

New MFC Front

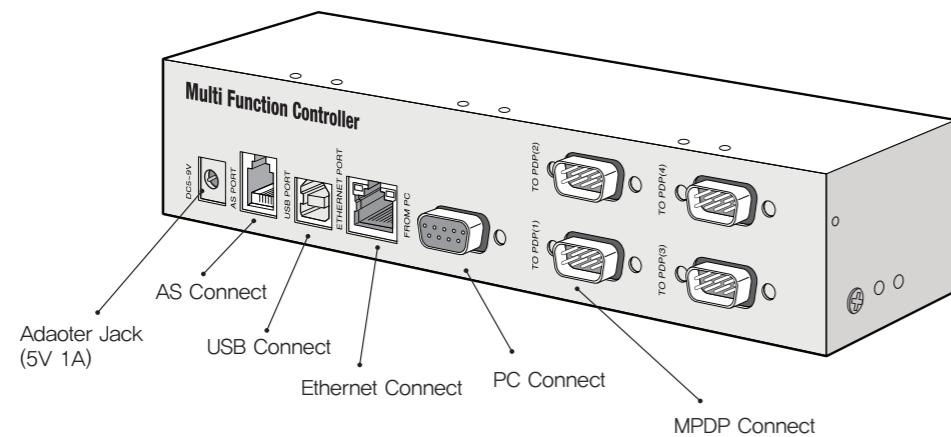

New MFC Rear

2) MPDP Set Configuration (e.g. X:5 sets x Y:6 sets)

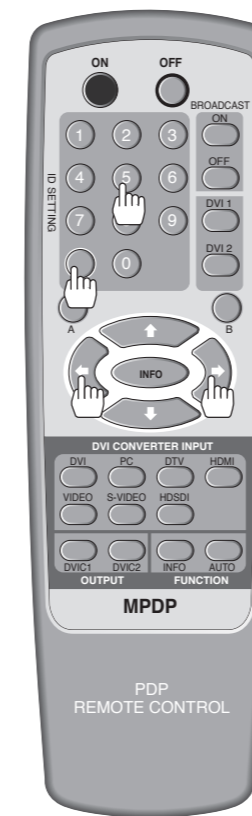

Horizontal configuration

1. Press SET button .



2. Press Left and Right buttons sequentially to enter the horizontal configuration mode.

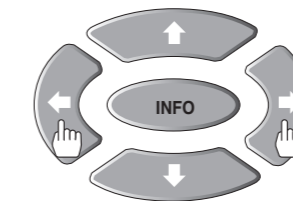

3. When the 2 LEDs at lower right corner of each 7-segment of lower line in the New MFC are turned on, the horizontal configuration mode is started.

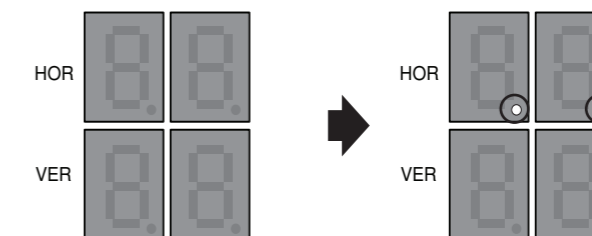

4. Use the number buttons to set the numbers of MPDP sets in horizontal line. —e.g. If you want to set 5 for horizontal number, press "0" for ten's place and "5" for one's place.

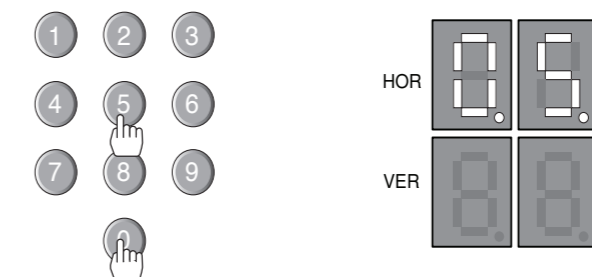

5. Press SET button to finish the horizontal configuration mode.



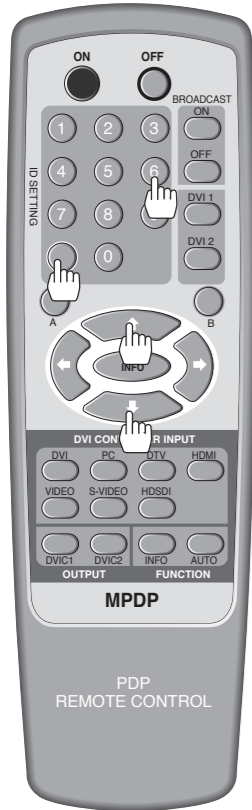

Vertical configuration

1. Press SET button.



2. Press Up and Down buttons sequentially to enter the vertical configuration mode.

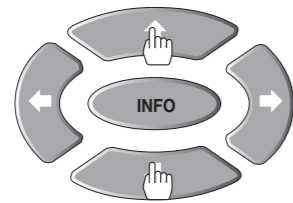

3. When the 2 LEDs at lower right corner of each 7-segment of lower line in the New MFC are turned on, the vertical configuration mode is started.

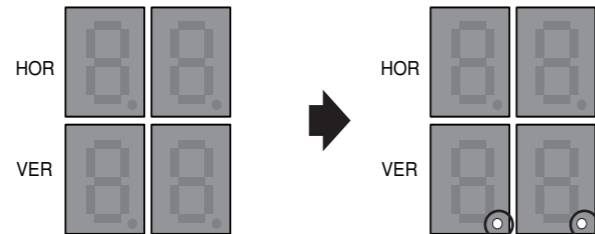

4. Use the number buttons to set the numbers of MPDP sets in horizontal line.
 -e.g. If you want to set 6 for vertical number, press "0" for ten's place and "6" for one's place.

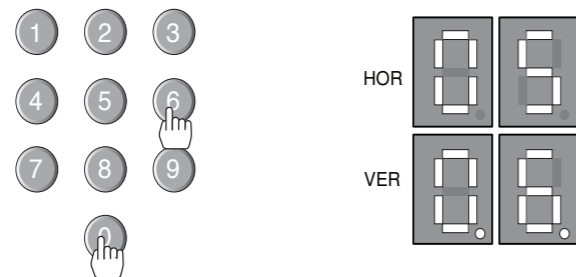

5. Press SET button to finish the vertical configuration mode.



5.14. DVI Converter

- To use DVI Converter, go to MSCS Menu → Device → DVI Converter or press "Ctrl+V" using Keyboard.

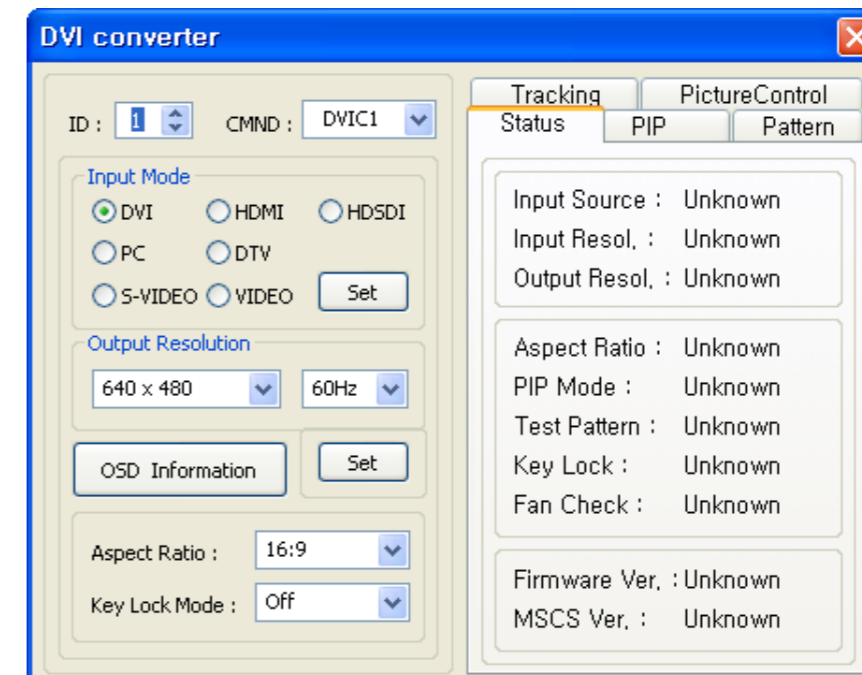
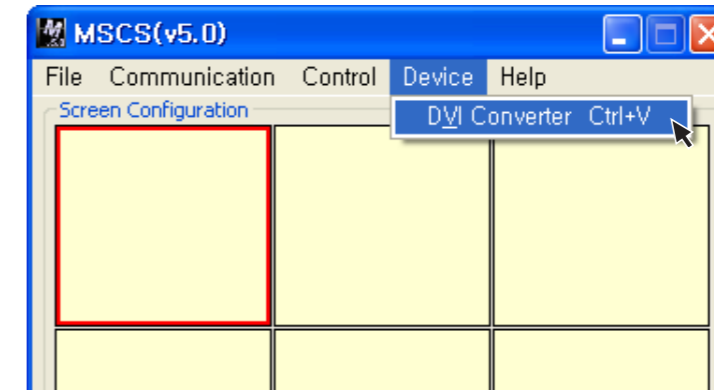

DVI Converter Dialog

1) ID

- Set the ID of DVI Converter. The ID can be selected from 1 to 9.

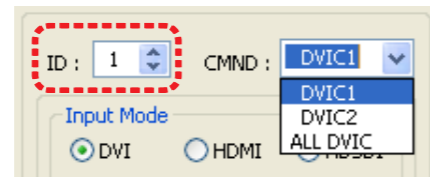

2) CMND

- Select the channel of DVI converter to control.
- One of DVI Channel 1(DVIC1), DVI Channel 2(DVIC2), and ALL DVI Channel can be selected.

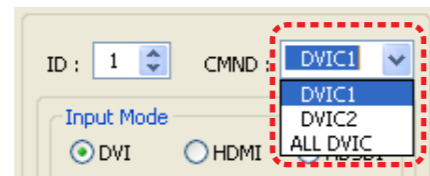

3) Input Mode

- Select the input mode of DVI Converter.
- One of DVI, HDMI, HDSDI, PC, DTV, S-VIDEO, and VIDEO can be selected.
- **Set** : Select one mode from 7 Input Modes and execute.

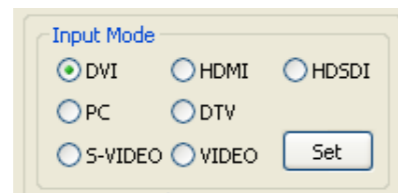

4) Output Resolution

- Set the output resolution of DVI Converter.

Resolution	frequency
640 x 480	60Hz 85Hz
800 x 600	50Hz 60Hz 85Hz
853 x 480	50Hz 60Hz
1024 x 768	60Hz 85Hz
1280 x 1024	50Hz 60Hz
1600 x 900	50Hz 60Hz
1600 x 1200	50Hz 60Hz
1706 x 960	60Hz

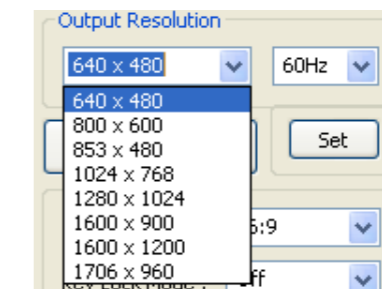

- **Set** : Set the output resolution.

5) OSD Information

- The DVI converter input and input resolution are displayed on the screen.

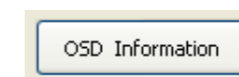

6) Aspect Ratio

- Set or change the screen ratio (Horizontal: Vertical)
- **16 : 9** : Set the screen ratio as 16:9 wide screen.
- **4 : 3** : Set the screen ratio as 4:3
- **LB(Letter Box)** : Expand the screen image to remove the black patterns at the top and bottom portions of the screen.
- **LBS(Letter Box Subtitle)** : Expand the screen with the subtitle to the top portion. (The bottom portion remains with black pattern)

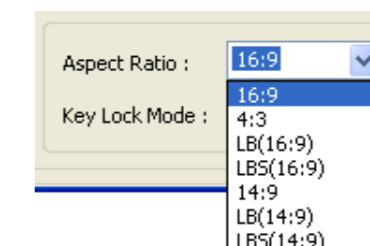

7) Key Lock Mode

- Lock the front key of DVI Converter not to turn On or Off.

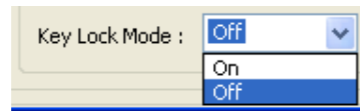

8) Status

- Display the DVI Converter status (Input Source, Input Resolution, Output Resolution, Aspect Ratio, PIP Mode, Test Pattern, Key Lock, Fan Check, Firmware Version, MSCS Version information)

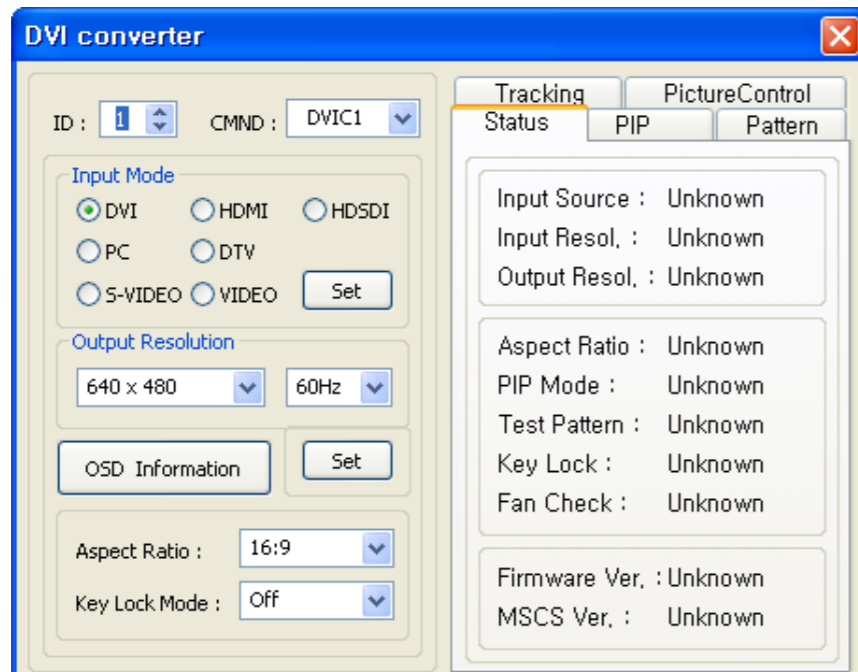

9) Picture Control

- Control the Brightness, Contrast, Sharpness, Color, and Tint of the DVI Converter.
- **Brightness** : The range of "Brightness" you can adjust is 0 to 100.
- **Contrast** : The range of "Contrast" you can adjust is 0 to 100.
- **Sharpness** : The range of "Sharpness" you can adjust is 0 to 28.
- **Color** : The range of "Color" you can adjust is 0 to 100.
- **Tint** : The range of "Tint" you can adjust is 0 to 90.
- **Firmware Default** : Initialize the adjusted values to the default values.

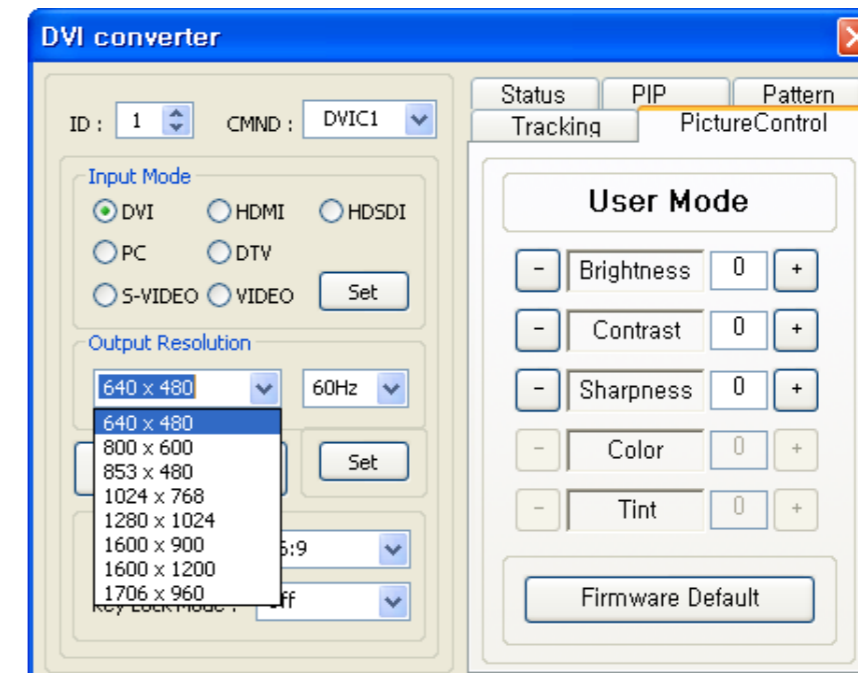

10) Pattern

- Select the Test Pattern (Red, Blue, 8-Color, 16-Gray, Green, White, White (10%), Screen)
- **Set** : Set or change the Pattern.

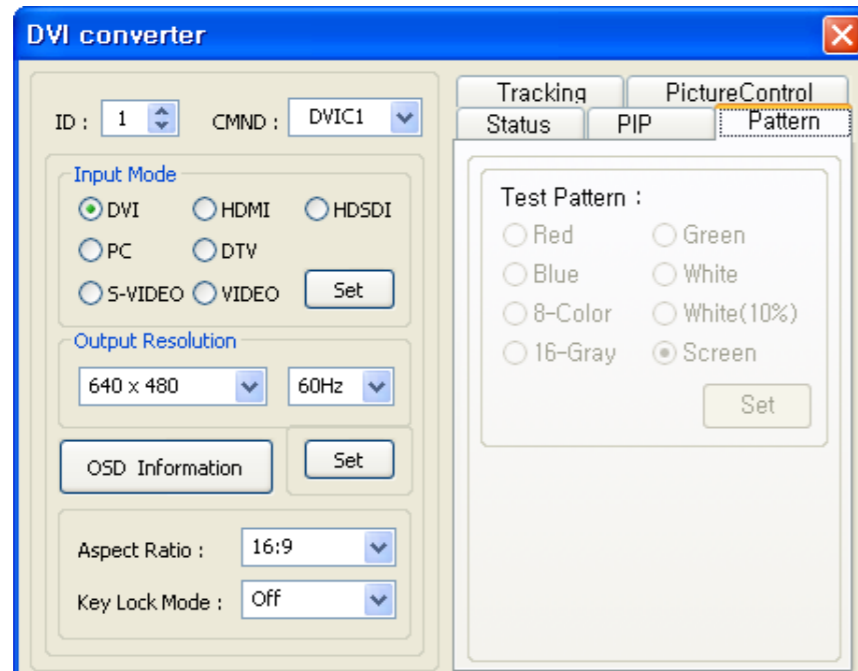

11) Tracking

- Control the Screen size, sharpness, and position of DVI Converter with PC input mode.
- In case alignment doesn't work through "Tracking Auto" command, users can tune finely through "Manual Tracking".
- "Manual Tracking" window enables users to set Frequency, Phase, LineStart and PixelStart.
- Detail adjustment steps are as follows.
 - 1) Tune "Phase" until the vertical lines are clearly adjusted..
 - 2) Tune "LineStart" to adjust vertical alignment, "PixelStart" for horizontal alignment.
 - 3) Adjust "Frequency" if alignment is still wrong.
If you adjust "Frequency", repeat step 1) and 2) to fit alignment.
Adjustable range is as follows
- **Frequency** : The range of "Frequency" you can adjust is -50 to 50
- **Phase** : The range of "Phase" you can adjust is 0 to 63
- **Linestart** : The range of "Linestart" you can adjust is -23 to 10
- **Pixelstart** : The range of "Pixelstart" you can adjust is -50 to 40
- **Auto Tracking** : Automatic alignment for DVI Converter screens.
- **Auto Calibration** : Automatic color control for DVI Converter screen.

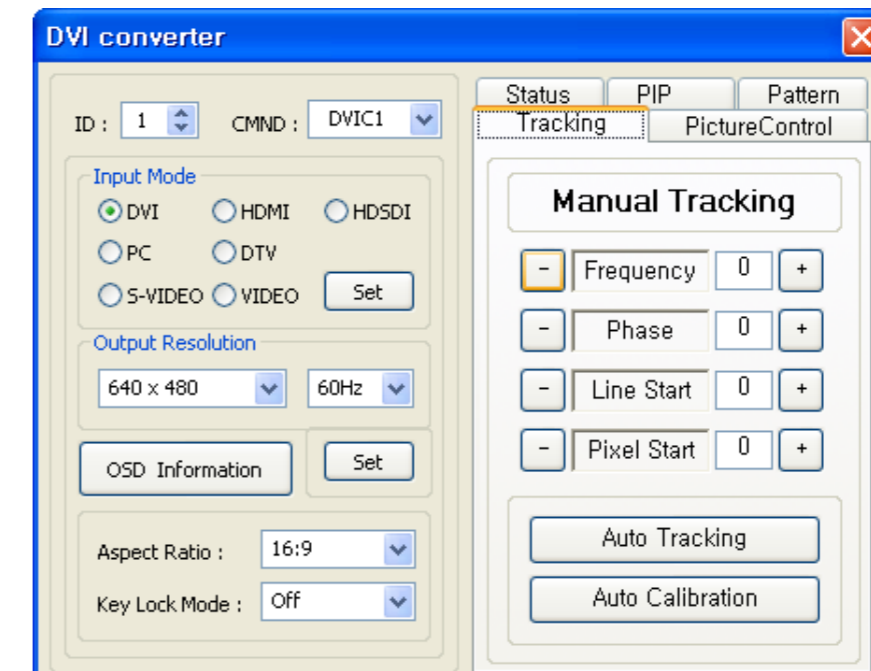

12) PIP(Picture In Picture)

- A variety of images can be displayed with the PIP function of DVI converter. To activate PIP, click "PIP" in the Mode. The position of sub-picture can be controlled by clicking - / + buttons increase or decrease the number or directly type in the numbers at Edit box.
- Various input sources can be used. To set the sub-input, click the sub-input combo box and select sub-input.
- Main screen and sub-screen can be swapped with the PIP Swap function. Press "Set" button at the right side of "PIP Swap." If you want to return to previous screen, press "Normal" button at the right side of "PIP Swap."
- **Mode** : Normal mode – Normal screen without PIP (PIP Off)
PIP mode–Sub-screen is displayed at the lower right corner of the screen. (PIP On)
- **Position** : Horizontal – Adjust the horizontal location of PIP. Adjustable range 0~100
Vertical – Adjust the vertical location of PIP. Adjustable range 0~100
- **Sub Input** : Set the input for PIP. One of DVI, HDMI, HDSDI, PC, DTV, S-VIDEO, and VIDEO can be selected for sub-input.

 ※ According to the main input, the sub-input can be restricted. If the main input is a digital input such as DVI, HDMI or HD-SDI, the sub-input should be an analog input such as PC, DTV, S-VIDEO or Video. If the main input is an analog input the sub-input should be a digital input.
- **PIP Swap** : Normal – Return to previous locations of swapped Main Source Input screen and Sub Source Input screen.
Set – Exchange the locations of Main Source Input screen and Sub Source Input screen.

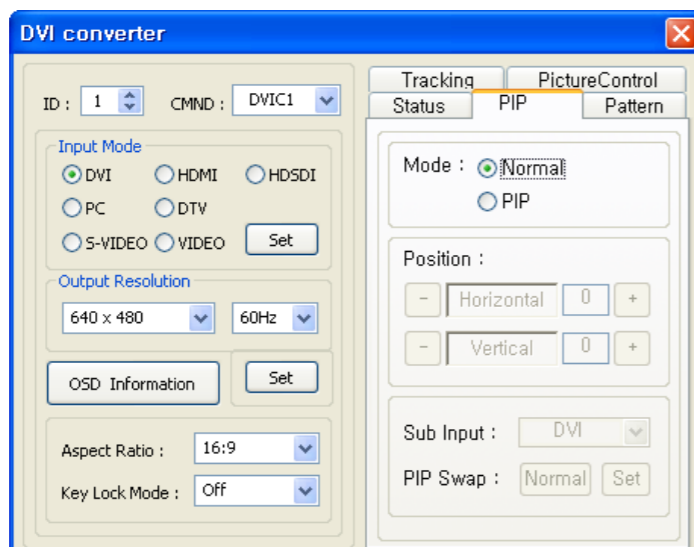

5.15. Orion PDP Home Page log on and Version Information

- In order to move to Orion PDP's website, go to "Help" of menu bar → "OrionDisplay HomePage".

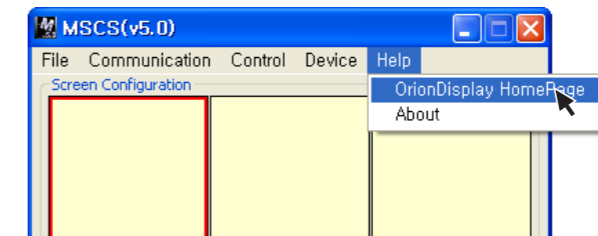

Orion PDP Home Page Log on

- Go to "Help" of menu bar → "About" to check MSCS.

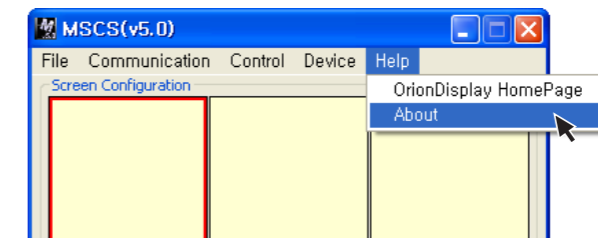

Checking MSCS Version

6. MSCS Protocol

1. Introduction

This chapter contains the communication protocol between PDP and its control devices such as computer for better use of the product. However, it does not include detailed technical matters. It rather focuses on the brief functional explanation and communication protocol.

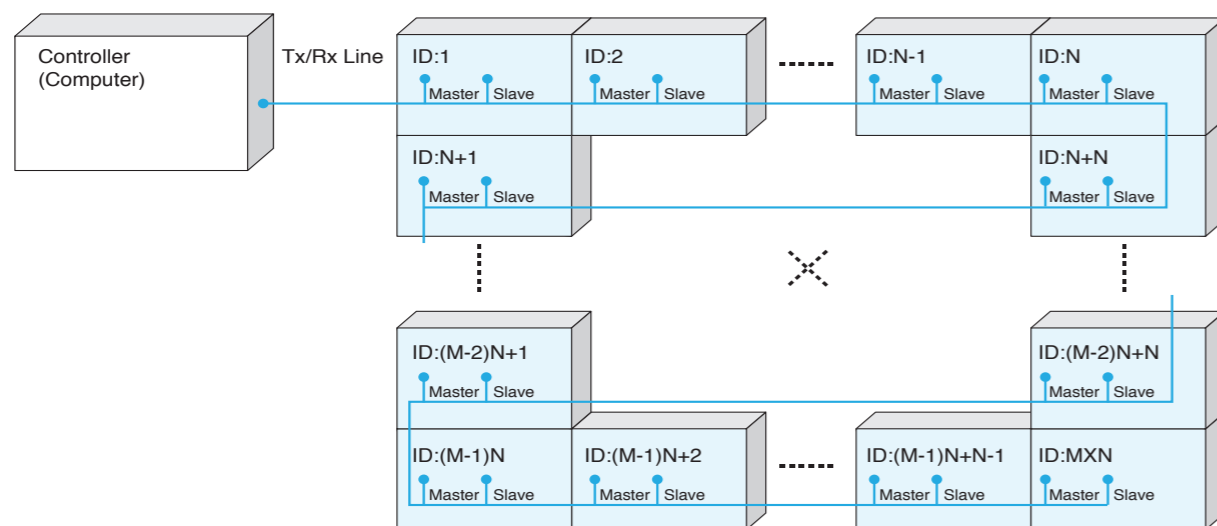

※ The connection can be variable based on environment or the users' intention.
< Communication connection diagram >

1.1. Communication Setting

- Transmission & Reception type: Asynchronous Serial Communication
- Connection type: Daisy Chain
- Baudrate : 115200
- Data Bits : 8
- Parity : None
- Stop Bits : 1
- Flow Control : None

2. Protocol Format

2.1. Send To PDP

STX	Command	Length	Data	ETX
1 byte	1 byte	1 byte	Variable	1 byte

ID	M/S	Other Data
1 byte	1 byte	N byte

- This is how to send commands to PDP. Only the set of the designated ID is working according to the "Command." But, if the "ID" value is "0", all MPDP sets are working according to command as "Broadcast".
- STX(0x02): The initial code. It means the beginning of Protocol. (Fixed value)
- Command: Code for actual operation. (Variable)
- Length: the length of "Data" area. (Variable: 0~255)
- Data: the areas for "ID" and the other Data (Variable)
- ID: It is a code to distinguish PDP sets. Its range is "0" to "255". If the ID is "0," it means Broadcast command.(variable)

- M/S: The classification codes for Master and Slave are "0x01" for Master and "0x00" for Slave. But, the data area for Master/Slave classification code does not exist in Broadcast command. Master/Slave classification code is fixed as "0x01" for "Factory data load" command.
- ETX(0x03): The end of the code. (Fixed value)

2.2. Receive From PDP

STX	CMD	Length	Data	Check Sum	ETX
1 byte	1 byte	1 byte	Variable	1 byte	1 byte

ID	M/S	Other Data
1 byte	1 byte	N byte

- Response by a certain command from the designated set among MPDP sets. The difference from "Send to PDP" is "Check sum".
- STX(0x02): The initial code. It means the beginning of Protocol. (Fixed value)
- Command: Code for actual operation. (Variable)
- Length: the length of "Data" area. (Variable: 0~255)
- Data: the areas for "ID" and the other Data (Variable)
- ID: Set identification (0~255) (Variable)
- M/S: The classification codes for Master and Slave are "0x01" for Master and "0x00" for Slave. Except for Broadcast command. (Variable)
- Check sum: execute "Not" operation after adding all the values in "STX~Data" area.
- ETX(0x03): The end of the code. (Fixed value)

3. Command

3.1. Power On

- Command for Power On: Operative status
- It is available only during Power Off(Stand-by) status.
- Send to MPDP

A. Normal command

Value	STX	CMD	Length	Data		ETX
	0x02	0x40	0x02	ID	M/S	0x03
				Variable	Variable	

* ID range(Program): 0x01(1) ~ 0xFF(255)

* M/S: Master (0x01), Slave (0x00)

B. Broadcast command

Value	STX	CMD	Length	Data: ID	ETX
	0x02	0x40	0x01	0x00	0x03

* Make all PDP (Master/Slave) do the same operation. But, there will be no return communication. (One way command)

- Receive from MPDP

Value	STX	CMD	Length	Data		Check Sum	ETX
	0x02	0x40	0x02	ID	M/S		
				Variable	Variable	Variable	0x03

* ID range (Program): 0x01(1) ~ 0xFF(255)

* M/S: Master (0x01), Slave (0x00)

* Check sum: execute "Not" operation after adding all the values in "STX~Data" area.

– "Power On" Communication Sequence

- * Wait for 40msec for response after sending the command. If there is no response, it is recommended to resend the command.
- * It is recommended that not sending the other command or changing input resolution during command transmission.
- * Command sequence: Slave → Master, (Except for Broadcast command)

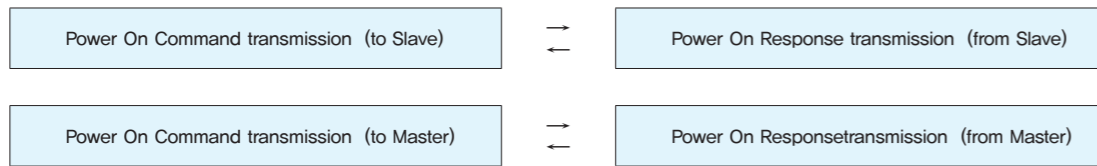

3.2. Power Off

- Command for Power Off : Stand-by status
- It is available only during Power On (Operative) status.
- Send to MPDP

A. Normal command

Value	STX	CMD	Length	Data		ETX
				ID	M/S	
	0x02	0x41	0x02	Variable	Variable	0x03

- * ID range(Program): 0x01(1) ~ 0xFF(255)
- * M/S: Master (0x01), Slave (0x00)

B. Broadcast command

Value	STX	CMD	Length	Data: ID	ETX
	0x02	0x41	0x01	0x00	0x03

- * Make all PDP (Master/Slave) do the same operation. But, there will be no return communication. (One way command)

– Receive from MPDP

Value	STX	CMD	Length	Data		Check Sum	ETX
				ID	M/S		
	0x02	0x41	0x02	Variable	Variable	Variable	0x03

- * ID range (Program): 0x01(1) ~ 0xFF(255)
- * M/S: Master (0x01), Slave (0x00)
- * Check sum: execute "Not" operation after adding all the values in "STX~Data" area.

– "Power Off" Communication Sequence

- * Wait for 40msec for response after sending the command. If there is no response, it is recommended to resend the command.
- * It is recommended that not sending the other command or changing input resolution during command transmission.
- * Command sequence: Slave → Master, (Except for Broadcast command)

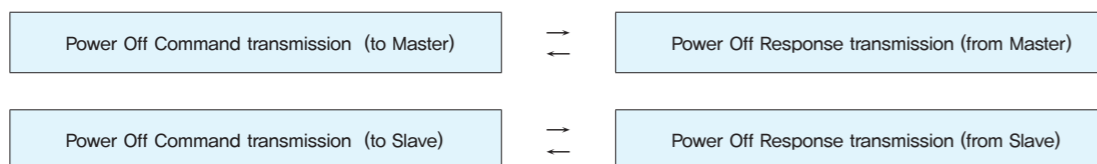

3.3. Multi-Scale

- Command for expanding the screen of MPDP.
- It is available only on Power On (Operative) status.
- CMD: 0xDD (DVI 1), 0xEF (DVI 2)
- Send to MPDP

A. Normal command

Value	STX	CMD	Length	Data				ETX
				ID	M/S	XY	P	
	0x02	Variable	0x04	Variable	Variable	Variable	Variable	0x03

- * ID range (Program): 0x01(1) ~ 0x64(100)
- * M/S: Master (0x01), Slave (0x00)
- * XY: The number of horizontal axis (X)/ the number of vertical axis(Y); upper 4 bits –X (Max:15), Lower 4bits – Y (Max: 15)
- * P: the location of expanded screen

B. Broadcast command

Value	STX	CMD	Length	Data				ETX
				ID	M/S	XY	P	
	0x02	Variable	0x04	0x00	Variable	Variable	Variable	0x03

- * ID: 0x00
- * XY: The number of MPDP sets in horizontal line(X), the number of MPDP sets in vertical line(Y)
The top 4bits – X (Max: 15), the bottom 4bits – Y (Max: 15)
1:1 screen ratio (Full screen) is "0x11"
- * S: The ID of MPDP to be expanded in top left position, 1:1 screen ratio (Full screen) is "0x00"
- * X: The number of all MPDP sets in horizontal line, 1:1 screen ratio (Full screen) is "0x01"
- * Make all PDP (Master/Slave) do the same operation. But, there will be no return communication. (One way command)
Broadcast command: e.g.) In case of 5x5 MPDP formation

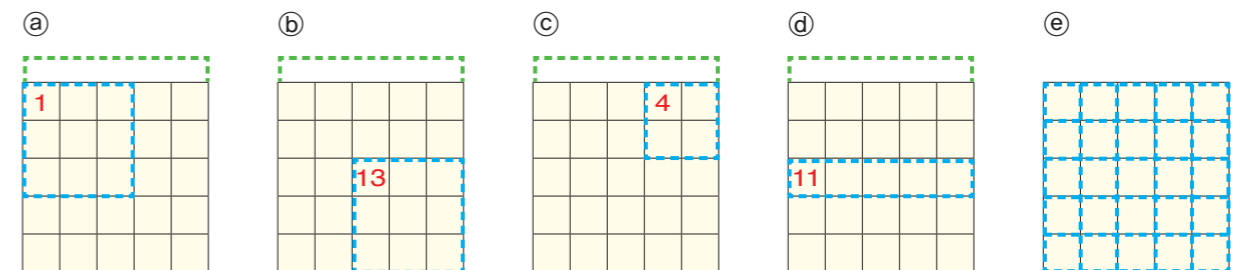

Ⓐ	0x02(STX)	0xDD(CMD)	0x04(Length)	0x00(ID)	0x33(XY)	0x01(S)	0x05(X)	0x03(ETX)
Ⓑ	0x02(STX)	0xDD(CMD)	0x04(Length)	0x00(ID)	0x33(XY)	0x0D(S)	0x05(X)	0x03(ETX)
Ⓒ	0x02(STX)	0xDD(CMD)	0x04(Length)	0x00(ID)	0x22(XY)	0x04(S)	0x05(X)	0x03(ETX)
Ⓓ	0x02(STX)	0xDD(CMD)	0x04(Length)	0x00(ID)	0x41(XY)	0x0B(S)	0x05(X)	0x03(ETX)
Ⓔ	0x02(STX)	0xDD(CMD)	0x04(Length)	0x00(ID)	0x11(XY)	0x00(S)	0x01(X)	0x03(ETX)

– Receive from MPDP

Value	STX	CMD	Length	Data		Check Sum	ETX
				ID	M/S		
	0x02	Variable	0x02	Variable	Variable	Variable	0x03

- * ID range (Program): 0x01(1) ~ 0xFF(255)
- * M/S: Master (0x01), Slave (0x00)
- * Check Sum: execute "Not" operation after adding all the values in "STX~Data" area.

– "Multi-Scale" Communication Sequence

- * Wait for 40msec for response after sending the command. If there is no response, it is recommended to resend the command.
- * It is recommended that not sending the other command or changing input resolution during command transmission.
- * Command sequence: Slave → Master.

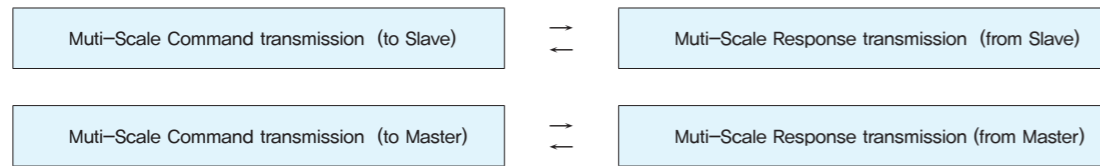

3.4. Information

- Command for displaying the information on the screen (Input source and resolution by OSD)
- It is available only on Power On (Operative) status.
- Send to MPDP

A. Normal command

Value	STX	CMD	Length	Data		ETX
				ID	M/S	
	0x02	0x42	0x02	Variable	Variable	0x03

- * ID range(Program): 0x01(1) ~ 0xFF(255)
- * M/S: Master (0x01), Slave (0x00)

B. Broadcast command

Value	STX	CMD	Length	Data: ID	ETX
	0x02	0x42	0x01	0x00	0x03

- * Make all PDP (Master/Slave) do the same operation. But, there will be no return communication. (One way command)

– Receive from MPDP

Value	STX	CMD	Length	Data		Check Sum	ETX
				ID	M/S		
	0x02	0x40	0x02	Variable	Variable	Variable	0x03

- * ID range (Program): 0x01(1) ~ 0xFF(255)
- * M/S: Master (0x01), Slave (0x00)
- * Check Sum: execute "Not" operation after adding all the values in "STX~Data" area.

– "Information" Communication Sequence

- * Wait for 40msec for response after sending the command. If there is no response, it is recommended to resend the command.
- * It is recommended that not sending the other command or changing input resolution during command transmission.
- * Command sequence: Slave → Master. (Except for Broadcast command)

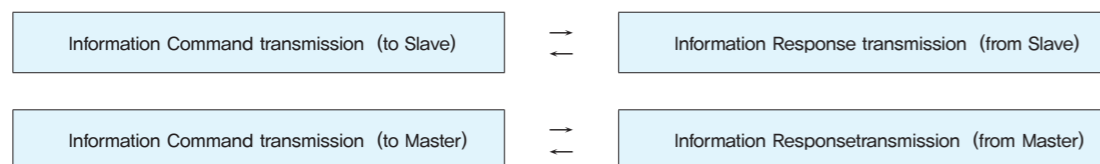

3.5. Input-Mode Change

- Command for changing input mode without screen scaling
- It is available only on Power On (Operative) status.
- CMD: 0x44 (DVI 1), 0xDC (DVI 2)
- Send to MPDP

A. Normal Command

Value	STX	CMD	Length	Data		ETX
				ID	M/S	
	0x02	Variable	0x02	Variable	Variable	0x03

- * ID range(Program): 0x01(1) ~ 0xFF(255)
- * M/S: Master (0x01), Slave (0x00)

B. Broadcast Command

Value	STX	CMD	Length	Data: ID	ETX
	0x02	Variable	0x01	0x00	0x03

- * Make all PDP (Master/Slave) do the same operation. But, there will be no return communication. (One way command)

– Receive from MPDP

Value	STX	CMD	Length	Data		Check Sum	ETX
				ID	M/S		
	0x02	Variable	0x02	Variable	Variable	Variable	0x03

- * ID range (Program): 0x01(1) ~ 0xFF(255)
- * M/S: Master (0x01), Slave (0x00)
- * Check Sum: execute "Not" operation after adding all the values in "STX~Data" area.

– "Input-Mode Change" Communication Sequence

- * Wait for 40msec for response after sending the command. If there is no response, it is recommended to resend the command.
- * It is recommended that not sending the other command or changing input resolution during command transmission.
- * Command sequence: Slave → Master. (Except for Broadcast command)

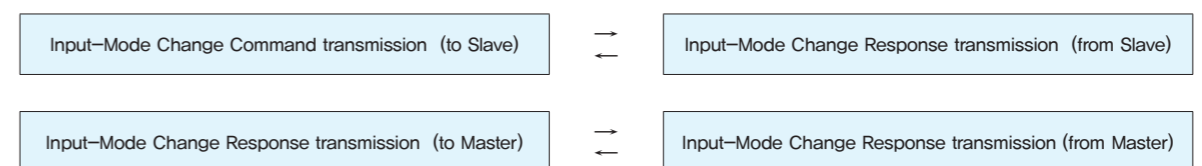

3.6. Auto-Power Mode

- Configuration for automatic power on by AC power connection.
- It is available only on Power On (Operative) status.
- CMD: 0x62(Set), 0x63(cancel)
- Send to MPDP

A. Normal Command

Value	STX	CMD	Length	Data		ETX
				ID	M/S	
	0x02	Variable	0x02	Variable	Variable	0x03

- * ID range(Program): 0x01(1) ~ 0xFF(255)
- * M/S: Master (0x01), Slave (0x00)

B. Broadcast Command

	STX	CMD	Length	Data: ID	ETX
Value	0x02	Variable	0x01	0x00	0x03

* Make all PDP (Master/Slave) do the same operation. But, there will be no return communication. (One way command)

– Receive from MPDP

	STX	CMD	Length	Data		Check Sum	ETX
				ID	M/S		
Value	0x02	Variable	0x02	Variable	Variable	Variable	0x03

* ID range (Program): 0x01(1) ~ 0xFF(255)

* M/S: Master (0x01), Slave (0x00)

* Check Sum: execute "Not" operation after adding all the values in "STX~Data" area..

– "Auto-Power Mode" Communication Sequence

* Wait for 40msec for response after sending the command. If there is no response, it is recommended to resend the command.

* It is recommended that not sending the other command or changing input resolution during command transmission.

* Command sequence: Slave → Master. (Except for Broadcast command)

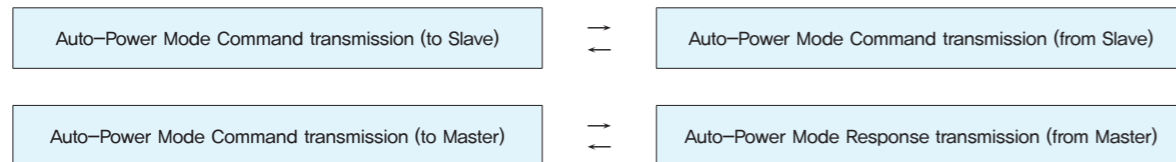

3.7. Test Pattern

– Command for checking the operating status with internal patterns

– It is available only on Power On (Operative) status.

– CMD: 0x57 (Red), 0x58 (Green), 0x59 (Blue), 0x5A (White), 0x5B (Screen)

– Send to MPDP

A. Normal Command

	STX	CMD	Length	Data		ETX
				ID	M/S	
Value	0x02	Variable	0x02	Variable	Variable	0x03

* ID range(Program): 0x01(1) ~ 0xFF(255)

* M/S: Master (0x01), Slave (0x00)

B. Broadcast Command

	STX	CMD	Length	Data: ID	ETX
Value	0x02	Variable	0x01	0x00	0x03

* Make all PDP (Master/Slave) do the same operation. But, there will be no return communication. (One way command)

– Receive from MPDP

	STX	CMD	Length	Data		Check Sum	ETX
				ID	M/S		
Value	0x02	Variable	0x02	Variable	Variable	Variable	0x03

* ID range (Program): 0x01(1) ~ 0xFF(255)

* M/S: Master (0x01), Slave (0x00)

* Check Sum: execute "Not" operation after adding all the values in "STX~Data" area.

– "Test Pattern" Communication Sequence

* Wait for 40msec for response after sending the command. If there is no response, it is recommended to resend the command.

* It is recommended that not sending the other command or changing input resolution during command transmission.

* Command sequence: Master → Slave. (Except for Broadcast command)

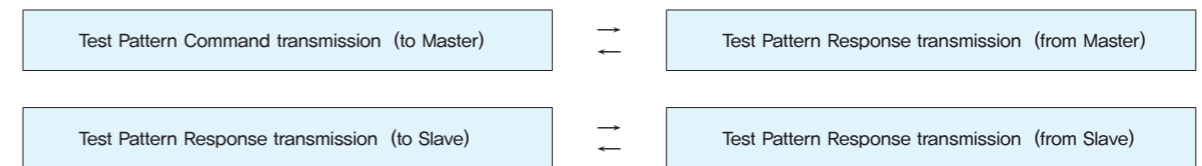

3.8. Global Offset

– Command for removing the image data in seam area (Set) or displaying all the data on the screen (Cancel.)

– It is available only on Power On (Operative) status.

– CMD: 0x74(Set), 0x73(Cancel)

– Send to MPDP

A. Normal Command

	STX	CMD	Length	Data		ETX
				ID	M/S	
Value	0x02	Variable	0x02	Variable	Variable	0x03

* ID range(Program): 0x01(1) ~ 0xFF(255)

* M/S: Master (0x01), Slave (0x00)

B. Broadcast Command

	STX	CMD	Length	Data: ID	ETX
Value	0x02	Variable	0x01	0x00	0x03

* Make all PDP (Master/Slave) do the same operation. But, there will be no return communication. (One way command)

– Receive from MPDP

	STX	CMD	Length	Data		Check Sum	ETX
				ID	M/S		
Value	0x02	Variable	0x02	Variable	Variable	Variable	0x03

* ID range (Program): 0x01(1) ~ 0xFF(255)

* M/S: Master (0x01), Slave (0x00)

* Check Sum: execute "Not" operation after adding all the values in "STX~Data" area.

– "Global Offset" Communication Sequence

* Wait for 40msec for response after sending the command. If there is no response, it is recommended to resend the command.

* It is recommended that not sending the other command or changing input resolution during command transmission.

* Command sequence: Slave → Master. (Except for Broadcast command)

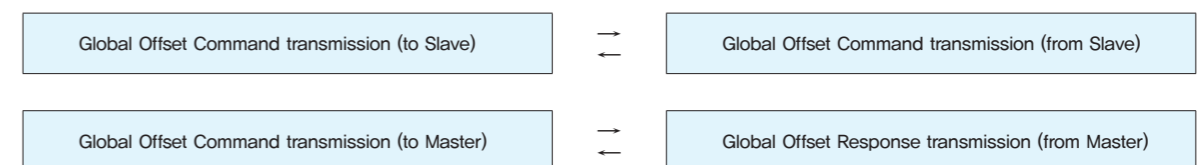

3.9. APL Control

- APL On/Soft/Off
- CMD: 0x54 (APL On), 0x55 (APL Soft), 0x56 (APL Off)
- It is available only on Power On (Operative) status.
- Send to MPDP

A. Normal Command

Value	STX	CMD	Length	Data		ETX
				ID	M/S	
	0x02	Variable	0x02	Variable	Variable	0x03

- * ID range(Program): 0x01(1) ~ 0xFF(255)
- * M/S: Master (0x01), Slave (0x00)

B. Broadcast Command

Value	STX	CMD	Length	Data: ID	ETX
	0x02	Variable	0x01	0x00	0x03

- * Make all PDP (Master/Slave) do the same operation. But, there will be no return communication. (One way command)

- Receive from MPDP

Value	STX	CMD	Length	Data		Check Sum	ETX
				ID	M/S		
	0x02	Variable	0x02	Variable	Variable	Variable	0x03

- * ID range (Program): 0x01(1) ~ 0xFF(255)
- * M/S: Master (0x01), Slave (0x00)
- * Check Sum: execute "Not" operation after adding all the values in "STX~Data" area.

- "APL Control" Communication Sequence

- * Wait for 40msec for response after sending the command. If there is no response, it is recommended to resend the command.
- * It is recommended that not sending the other command or changing input resolution during command transmission.
- * Command sequence: Master → Slave. (Except for Broadcast command)

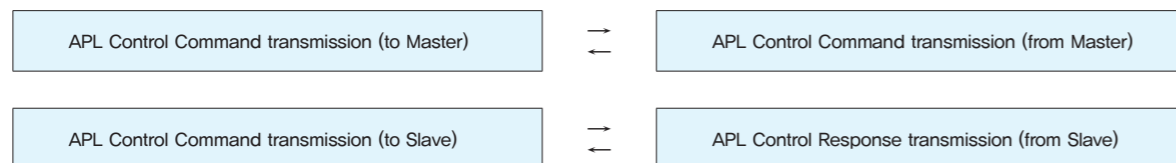

3.10. Color Temperature

- Normal mode is 9300 and Studio mode is 3600.
- Normal mode is applicable for general purpose and Studio mode is designed for broadcasting purpose. (Default: Normal Mode)
- It is available only on Power On (Operative) status.
- CMD: 0xB3 (Normal), 0xB4 (Studio: broadcasting purpose)
- Send to MPDP

A. Normal Command

Value	STX	CMD	Length	Data		ETX
				ID	M/S	
	0x02	Variable	0x02	Variable	Variable	0x03

- * ID range(Program): 0x01(1) ~ 0xFF(255)
- * M/S: Master (0x01), Slave (0x00)

B. Broadcast Command

Value	STX	CMD	Length	Data: ID	ETX
	0x02	Variable	0x01	Variable	0x03

- * Make all PDP (Master/Slave) do the same operation. But, there will be no return communication. (One way command)

- Receive from MPDP

Value	STX	CMD	Length	Data		Check Sum	ETX
				ID	M/S		
	0x02	Variable	0x02	Variable	Variable	Variable	0x03

- * ID range (Program): 0x01(1) ~ 0xFF(255)
- * M/S: Master (0x01), Slave (0x00)
- * Check Sum: execute "Not" operation after adding all the values in "STX~Data" area.

- "Color Temperature" Communication Sequence

- * Wait for 40msec for response after sending the command. If there is no response, it is recommended to resend the command.
- * It is recommended that not sending the other command or changing input resolution during command transmission.
- * Command sequence: Slave → Master. (Except for Broadcast command)

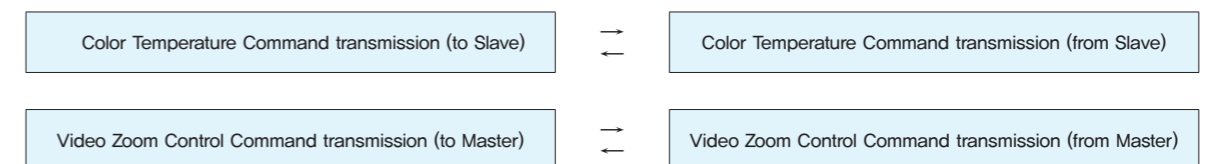

3.11. Elapsed Time: Only Master

- Command for informing the elapsed time of each PDP set. (Basic unit: hour)
- It is available only on Power On (Operative) status.
- Send to MPDP

Value	STX	CMD	Length	Data		ETX
				ID	M/S	
	0x02	0x77	0x02	Variable	Variable	0x03

- * ID range (Program): 0x01(1) ~ 0xFF(255)
- * M/S: Since it is only Master, "0x01" Value must be transmitted.
- * It is not applicable as "Broad-cast" command and only master can be usable.

- Receive from MPDP

Value	STX	CMD	Length	Data			Check Sum	ETX
				ID	M/S	Elapsed Time		
	0x02	0x77	0x08	Variable	Variable	...	Variable	0x03

Hundred thousands	ten thousands	thousands	hundreds	ten	one
Variable	Variable	Variable	Variable	Variable	Variable

- * ID range(Program): 0x01(1) ~ 0xFF(255)
- * M/S: Since it is only Master, "0x01" Value must be transmitted.
- * Check Sum: Execute "Not" operation after adding all the values in "STX~Data" area.
- * Elapsed Time
 - Hundred thousands, ten thousands, thousands, hundreds, tens, ones: 0(0x00)~9(0x09) range value.

- "Elapsed Time" Communication Sequence

- * Wait for 500msec for response after sending the command. If there is no response, it is recommended to resend the command.
- * It is recommended that not sending the other command or changing input resolution during command transmission.



3.12. IP Serial Number

- Command for assigning and identifying the serial numbers of each IP board. (8 digit)
CMD: 0x75 (Get S/N), 0x76 (Set S/N)

- Send to MPDP

Value	STX	CMD	Length	Data		ETX
				ID	M/S	
	0x02	Variable	0x02	Variable	Variable	0x03

- * ID range (Program): 0x01(1) ~ 0xFF(255)
- * M/S: Master (0x01), Slave (0x00)
- * "Get/Set IP Serial Number"(0x75/0x76) command is not applicable as "Broad-cast" command, because each PDP should have a unique serial number.

- Receive from MPDP

Value	STX	CMD	Length	Data			Check Sum	ETX
				ID	M/S	Elapsed Time		
	0x02	Variable	0x0A	Variable	Variable	...	Variable	0x03

0	1st	2nd	3rd	4th	5th	6th	7th
Variable	Variable	Variable	Variable	Variable	Variable	Variable	Variable

- * ID range(Program): 0x01(1) ~ 0xFF(255)
- * M/S: Master (0x01), Slave (0x00)
- * Check Sum: Execute "Not" operation after adding all the values in "STX~Data" area.
- * Elapsed Time
 - 0, 1st, 2nd, 3rd, 4th, 5th, 6th, 7th: 0(0x00)~9(0x09) range value

- "Elapsed Time" Communication Sequence

- * Wait for 500msec for response after sending the command. If there is no response, it is recommended to resend the command.
- * It is recommended that not sending the other command or changing input resolution during command transmission.
- * The serial number can be saved in any one of Master or Slave.



3.13. Default Data Load (Picture Control Data)

- Initialize the PDP set. All the settings will be returned to the initial condition prior to the adjustment in the factory. Pre-programmed value will be applied.
- It is available only on Power On (Operative) status.
- Since previous Picture Control Data will be lost with this command. High caution is required.
- Send to MPDP

A. Normal Command

Value	STX	CMD	Length	Data		ETX
				ID	M/S	
	0x02	0x81	0x02	Variable	Variable	0x03

- * ID range(Program): 0x01(1) ~ 0xFF(255)
- * M/S: Master (0x01), Slave (0x00)

B. Broadcast Command

Value	STX	CMD	Length	Data: ID	ETX
	0x02	0x81	0x01	Variable	0x03

- * Make all PDP (Master/Slave) do the same operation. But, there will be no return communication. (One way command)

- Receive from MPDP

Value	STX	CMD	Length	Data		Check Sum	ETX
				ID	M/S		
	0x02	0x81	0x02	Variable	Variable	Variable	0x03

- * ID range(Program): 0x01(1) ~ 0xFF(255)
- * M/S: Master (0x01), Slave (0x00)
- * Check Sum: Execute "Not" operation after adding all the values in "STX~Data" area.

- "Default Data Load" Communication Sequence

- * Wait for 40msec for response after sending the command. If there is no response, it is recommended to resend the command.
- * It is recommended that not sending the other command or changing input resolution during command transmission.
- * Except for Broadcast command



3.14. BIC (Burn-In Compensation): Only Master

- BIC function helps reducing burn-in effect. Please refer to User manual for further explanation.
- It is available only on Power On (Operative) status.
- Send to MPDP

A. "Set" command from "Get/Set" in "Data" area

Value	STX	CMD	Length	Data			ETX
				ID	M/S	Setting Values	
	0x02	0x6A	0x09	Variable	Variable	...	0x03

Value bit	Get/Set	Address	Value
Variable	0x00	Variable	...

Value3	Value2	Value1	Value0
Variable	Variable	Variable	Variable

B. "Get" command from "Get/Set" in "Data" area

	STX	CMD	Length	Data			ETX
				ID	M/S	Setting Values	
Value	0x02	0x6A	0x05	Variable	Variable	...	0x03

Value bit	Get/Set	Address
Variable	0x01	Variable

- * ID range (Program): 0x01(1) ~ 0xFF(255)
- * M/S: Since it is only Master, "0x01" Value must be transmitted.
- * Setting Values
 - Value bit: Area for setting 8, 16, and 32bit. Currently, 32bit setting is used. (8bit: 0x01 / 16bit: 0x02 / 32bit: 0x04)
 - Get/Set: Read or write data in a designated address. (Get: 0x01, Set: 0x00)
 - Address: The address in the internal register of BIC module.
 - Value: The length of data can be variable according to the settings of "Value bit" area. Currently, 32bit data is used.
- * Broad-cast: All PDP(Only Master) sets will execute the same command, when the ID is 0x00. No response (One way command)
 "Get" command from "Get/Set" in "Data" area is applied, "Broad-cast" command cannot be executed.

- Receive from MPDP

A. Response for "Set" command from "Get/Set" in "Data" area

	STX	CMD	Length	Data		Check Sum	ETX
				ID	M/S		
Value	0x02	0x6A	0x02	Variable	0x01	Variable	0x03

- * ID range(Program): 0x01(1) ~ 0xFF(255)
- * M/S: Since it is only Master, "0x01" Value must be transmitted.
- * Check Sum: Execute "Not" operation after adding all the values in "STX~Data" area.

B. Response for "Get" command from "Get/Set" in "Data" area

	STX	CMD	Length	Data				ETX
				ID	M/S	Setting Values		
Value	0x02	0x6A	0x09	Variable	Variable	...		0x03

Value bit	Get/Set	Address	Value
Variable	Variable	Variable	...

Value3	Value2	Value1	Value0
Variable	Variable	Variable	Variable

- * ID range(Program): 0x01(1) ~ 0xFF(255)
- * M/S: Since it is only Master, "0x01" Value must be transmitted.
- * Getting Values
 - Value bit: Area for setting 8, 16, and 32bit. Currently, 32bit setting is used. (8bit: 0x01 / 16bit: 0x02 / 32bit: 0x04)
 - Get/Set: Response for "Get" is "0x01."
 - Address: The address in the internal register of BIC module.
 - Value: The length of data can be variable according to the settings of "Value bit" area. Currently, 32bit data is used
- * Check Sum: Execute "Not" operation after adding all the values in "STX~Data" area.

- "BIC" Communication Sequence

- * Wait for 1000msec for response after sending "Get," 40msec for "Set" commands. If there is no response, it is recommended to resend the command.
- * It is recommended that not sending the other command or changing input resolution during command transmission.



3.15. Graphic User Mode Control

- Command for controlling Brightness, Contrast, Sharpness, Color and Tint
- CMD: 0x8A (Brightness), 0x8B (Contrast), 0x8C (Sharpness)
- It is available only on Power On (Operative) status.
- The adjusted value is not applied during Stand-by or No-signal status. MPDP must be operating status and there must be the input signal of each mode.
- Send to MPDP

A. Normal Command

	STX	CMD	Length	Data			ETX
				ID	M/S	Value	
Value	0x02	Variable	0x03	Variable	Variable	Variable	0x03

- * ID range(Program): 0x01(1) ~ 0xFF(255)
- * M/S: Master (0x01), Slave (0x00)
- * Value:
 - General Input Mode : Brightness ("0" ~ "100"), Contrast ("0" ~ "100"), Sharpness ("0" ~ "28")

B. Broadcast Command

	STX	CMD	Length	Data		ETX
				ID	Value	
Value	0x02	Variable	0x02	Variable	Variable	0x03

- * Make all PDP (Master/Slave) do the same operation. But, there will be no return communication. (One way command)
- * Value:
 - General Input Mode: Brightness ("0" ~ "100"), Contrast ("0" ~ "100"), Sharpness ("0" ~ "28")

- Receive from MPDP

	STX	CMD	Length	Data		Check Sum	ETX
				ID	M/S		
Value	0x02	Variable	0x02	Variable	Variable	Variable	0x03

- * ID range (Program): 0x01(1) ~ 0xFF(255)
- * M/S: Master (0x01), Slave (0x00)
- * Check Sum: Execute "Not" operation after adding all the values in "STX~Data" area.

- "Graphic User Mode Control" Communication Sequence

- * Wait for 40msec for response after sending the command. If there is no response, it is recommended to resend the command.
- * It is recommended that not sending the other command or changing input resolution during command transmission.
- * Except for Broadcast command



3.16. White Balance Control

- Command for adjusting Gain R/G/B and Offset R/G/B for White balance
- CMD: 0xAC (Gain R), 0xAD (Gain G), 0xAE (Gain B), 0xB0 (Offset R), 0xB1 (Offset G), 0xB2 (Offset B)
- The adjusted value is not applied during Stand-by or No-signal status. MPDP must be operating status and there must be the input signal of each mode.
- To apply the same configuration to all MPDP sets, the "ID" area value can be set as "0x00." However, considering differences between sets, individual adjustment for white balance is recommended.

– Send to MPDP

A. Normal Command

	STX	CMD	Length	Data			ETX
				ID	M/S	Value	
Value	0x02	Variable	0x03	Variable	Variable	Variable	0x03

* ID range(Program): 0x01(1) ~ 0xFF(255)

* M/S: Master (0x01), Slave (0x00)

* Value: "0 (0x00)" ~ "255 (0xFF)"

B. Broadcast Command

	STX	CMD	Length	Data		ETX
				ID	Value	
Value	0x02	Variable	0x02	Variable	Variable	0x03

* Make all PDP (Master/Slave) do the same operation. But, there will be no return communication. (One way command)

* Value: "0 (0x00)" ~ "255 (0xFF)"

– Receive from MPDP

	STX	CMD	Length	Data		Check Sum	ETX
				ID	M/S		
Value	0x02	Variable	0x02	Variable	Variable	Variable	0x03

* ID range (Program): 0x01(1) ~ 0xFF(255)

* M/S: Master (0x01), Slave (0x00)

* Check Sum: Execute "Not" operation after adding all the values in "STX~Data" area.

– "White Balance Control" Communication Sequence

* Wait for 40msec for response after sending the command. If there is no response, it is recommended to resend the command.

* It is recommended that not sending the other command or changing input resolution during command transmission.

* Except for Broadcast command



3.17. Get Current Status

– Command for obtain the current PDP (IP) information

– CMD: 0x87(Master), 0x67(Slave)

– It is available only on Power On (Operative) status.

– Send to MPDP

	STX	CMD	Length	Data			ETX
				ID	M/S	Status	
Value	0x02	Variable	0x02	Variable	Variable	0x03	

* ID range (Program): 0x01(1) ~ 0xFF(255)

* M/S: Master (0x01), Slave (0x00)

* It cannot be used as "Broad-cast" command.

– Receive from MPDP

	STX	CMD	Length	Data			Check Sum	ETX
				ID	M/S	Status		
Value	0x02	Variable	0x23	Variable	Variable	...	Variable	0x03

* ID range(Program): 0x01(1) ~ 0xFF(255)

* M/S: Master (0x01), Slave (0x00)

* Check Sum: Execute "Not" operation after adding all the values in "STX~Data" area.

* Status (32 byte)

No.	Data	Length	Explanation
1	PWR Status	1 byte	0: Power Off (Stand-by), 1: Power On (Working)
2	Input Source	1 byte	0x0C: PC, 0x0E: DVI, 0x0D: DTV, 0x07: DVD, 0x05: S-Video, 0x02: Video
3	Resolution	1 byte	The value of "Displayed Resolution at the time of detection"
4	BIC Mode	1 byte	0: BIC Off, 1: BIC On
5	Global Offset	1 byte	0: Global Offset Off, 1: Global Offset On
6	Color Temp.	1 byte	0: Normal mode, 1: Studio mode
7	Auto-Power Mode	1 byte	0: Auto-Power Off, 1: Auto-Power On
8	APL	1 byte	0:Off, 1: On, 2: Soft
9	Temperature0	1 byte	0(0x00): 0°C - 127(0x7F): 127°C / 128(0x80): -1°C - 254(0xFE): -127°C 0xFF: Temp. Sensor Error
10	Temperature1	1 byte	0(0x00): 0°C - 127(0x7F): 127°C / 128(0x80): -1°C - 254(0xFE): -127°C 0xFF: Temp. Sensor Error
11	FAN Status	1 byte	0x30: Good, 0x31: Error
12-18	F/W Version	7 byte	Year: 2 byte, Month: 2byte, Day: 2byte, Rev.(0~9):1byte Ex) December 29th, 2012 Rev. 2 → 0x01 0x02 0x01 0x02 0x02 0x09 0x02
19	Video Zoom Level	1 byte	Default: 5, Range: 1 ~ 9
20-27	S/N	8 byte	123456 → 0x00 0x00 0x01 0x02 0x03 0x04 0x05 0x06 1 → 0x00 0x00 0x00 0x00 0x00 0x00 0x00 0x01
28-33	Elapsed Time	6 byte	54321 → 0x00 0x05 0x04 0x03 0x02 0x01 10 → 0x00 0x00 0x00 0x00 0x01 0x00

※ Since red color or italic letters are not the value detected from "Slave," they will respond as follows.

BIC mode: 0xFF

Temperature0: 0(0x00)

Temperature1: 0(0x00)

Elapsed Time: 0(0x00), 0(0x00), 0(0x00), 0(0x00), 0(0x00), 0(0x00)

< Displayed Resolution at the time of detection (It is different from the supporting Resolution) >

Resolution	Value	Resolution	Value	Resolution	Value
640x480x60	0(0x00)	720Px50	21(0x15)	1360x768x60	45(0x2D)
640x480x85	1(0x01)	576Px50	22(0x16)	640x350x85	46(0x2E)
800x600x56	2(0x02)	480Px60	23(0x17)	640x480x75	47(0x2F)
800x600x60	3(0x03)	1920x1080ix60	24(0x18)	640x480x72	48(0x30)
800x600x75	4(0x04)	1920x1080ix50	25(0x19)	1152x864x75	49(0x31)
800x600x85	5(0x05)	1280x720Px60	26(0x1A)	1280x720x60	50(0x32)
853x480x60	6(0x06)	1280x720Px50	27(0x1B)	1280x768x75	51(0x33)
1024x768x60	7(0x07)	PAL	28(0x1C)	1280x1024x75	52(0x34)
1024x768x70	8(0x08)	SECAM	29(0x1D)	1366x768x50	53(0x35)
1024x768x75	9(0x09)	PALP	30(0x1E)	1400x1050x50	54(0x36)
1024x768x85	10(0x0A)	NTSC	31(0x1F)	1440x900x60	55(0x37)
1280x768x60	11(0x0B)	NTSCP	32(0x20)	576ix50	56(0x38)
1280x960x60	12(0x0C)	Unknown	34(0x22)	480ix60	57(0x39)
1280x1024x60	13(0x0D)	No-Signal	35(0x23)	1080px60	58(0x3A)
1366x768x60	14(0x0E)	853x480x50	38(0x26)	1080px50	59(0x3B)
1600x1200x60	15(0x0F)	1280x1024x50	39(0x27)	1920x1080px60	60(0x3C)
1400x1050x60	16(0x10)	1360x768x50	40(0x28)	1920x1080px50	61(0x3D)
1706x960x60	17(0x11)	1600x900x50	41(0x29)	1024x576x50	62(0x3E)
1080ix60	18(0x12)	1600x900x60	42(0x2A)	1024x576x60	63(0x3F)
1080ix50	19(0x13)	1600x1200x50	43(0x2B)		
720Px60	20(0x14)	800x600x50	44(0x2C)		

※ The resolutions written in red or italic letters can be detected, but they are not supporting resolutions.

– "Get Current Status" Communication Sequence

- * Wait for 800msec for response after sending the command. If there is no response, it is recommended to resend the command.
- * It is recommended that not sending the other command or changing input resolution during command transmission.



3.18. Get Picture Control Data

- Command for acquiring the current Picture Control Data(User Mode, White Balance, Graphic, Video)
- CMD: 0x88(Master), 0x68(Slave)
- It is available only on Power On (Operative) status.
- The values based on current Color Temp. (Normal Mode / Studio Mode) will be displayed.
- Send to MPDP

Value	STX	CMD	Length	Data		ETX
				ID	M/S	
Value	0x02	Variable	0x02	Variable	Variable	0x03

- * ID range(Program): 0x01(1) ~ 0xFF(255)
- * M/S: Master (0x01), Slave (0x00)
- * It is not applicable as "Broad-cast" command.

– Receive from MPDP

Value	STX	CMD	Length	Data			Check Sum	ETX
				ID	M/S	Values		
Value	0x02	Variable	0x0D	Variable	Variable	...	Variable	0x03

- * ID range(Program): 0x01(1) ~ 0xFF(255)
- * M/S: Master (0x01), Slave (0x00)
- * Values (11 byte)

No.	Data	Length	Explanation
1	User Mode – Brightness	1 byte	Range: 0(0x00) ~ 100(0x64)
2	User Mode – Contrast	1 byte	Range: 0(0x00) ~ 100(0x64)
3	User Mode – Sharpness	1 byte	Range: 0(0x00) ~ 28(0x1C)
4	User Mode – Color	1 byte	Range: 0(0x00) ~ 100(0x64)
5	User Mode – Tint	1 byte	Range: 0(0x00) ~ 90(0x5A)
6	White Balance – Gain R	1 byte	Range: 0(0x00) ~ 255(0xFF)
7	White Balance – Gain G	1 byte	Range: 0(0x00) ~ 255(0xFF)
8	White Balance – Gain B	1 byte	Range: 0(0x00) ~ 255(0xFF)
9	White Balance – Offset R	1 byte	Range: 0(0x00) ~ 255(0xFF)
10	White Balance – Offset G	1 byte	Range: 0(0x00) ~ 255(0xFF)
11	White Balance – Offset B	1 byte	Range: 0(0x00) ~ 255(0xFF)

– "Get Picture Control Data" Communication Sequence

- * Wait for 800msec for response after sending the command. If there is no response, it is recommended to resend the command.
- * It is recommended that not sending the other command or changing input resolution during command transmission.



3.19. Factory Data Load (Picture Control Data): Only Master

- Command for loading the Picture Control data (User Mode / White Balance / RGB Data / DTV Data / DVD Data / VIDEO Data) adjusted in the factory. (This is different from "Default Data Load")
- It is usable only at Power on status and only Master is operating.
- It shows the value based on current Color Temp. (Normal Mode / Studio Mode.)
- Data can be checked with "Get Picture Control Data" after executing the command
- Send to MPDP

A. Normal Command

Value	STX	CMD	Length	Data		ETX
				ID	M/S	
Value	0x02	0x83	0x02	Variable	0x01	0x03

- * ID range(Program): 0x01(1) ~ 0xFF(255)
- * M/S: Since it is only Master, "0x01" Value is transmitted.

B. Broadcast Command

- * Make all PDP (Master/Slave) do the same operation. But, there will be no return communication. (One way command)
- * ID: 0x00
- *M/S : Since it is only Master, "0x01" Value is transmitted.

– Receive from MPDP

Value	STX	CMD	Length	Data		Check Sum	ETX
				ID	M/S		
Value	0x02	0x83	0x02	Variable	0x01	Variable	0x03

- * ID range(Program): 0x01(1) ~ 0xFF(255)
- M/S: Since it is only Master, "0x01" Value is transmitted..
- * Check Sum: Execute "Not" operation after adding all the values in "STX~Data" area.

– "Factory Data Load" Communication Sequence

- * Wait for 40msec for response after sending the command. If there is no response, it is recommended to resend the command.
- * It is recommended that not sending the other command or changing input resolution during command transmission.



3.20. DVI Over-Scan On/Off

- Users can select Over-scan when input is DTV resolution from DVI. It is only available with DVI mode.
- CMD: 0xE4(On), 0xE5(Off)
- It is usable only at Power on status and only Master is operating.
- Send to MPDP

A. Normal Command

Value	STX	CMD	Length	Data		ETX
				ID	M/S	
Value	0x02	Variable	0x02	Variable	Variable	0x03

- * ID range(Program): 0x01(1) ~ 0xFF(255)
- * M/S: Master (0x01), Slave (0x00)

B. Broadcast Command

Value	STX	CMD	Length	Data: ID	ETX
Value	0x02	Variable	0x01	0x00	0x03

- * Make all PDP (Master/Slave) do the same operation. But, there will be no return communication. (One way command)

– Receive from MPDP

Value	STX	CMD	Length	Data		Check Sum	ETX
				ID	M/S		
	0x02	Variable	0x02	Variable	Variable	Variable	0x03

* ID range (Program): 0x01(1) ~ 0xFF(255) * M/S: Master (0x01), Slave (0x00)
 * Check Sum: Execute "Not" operation after adding all the values in "STX~Data" area.

– "DVI Over-Scan On/Off" Communication Sequence

* Wait for 40msec for response after sending the command. If there is no response, it is recommended to resend the command.
 * It is recommended that not sending the other command or changing input resolution during command transmission.
 * Command sequence: Slave → Master. (Except for Broadcast command)

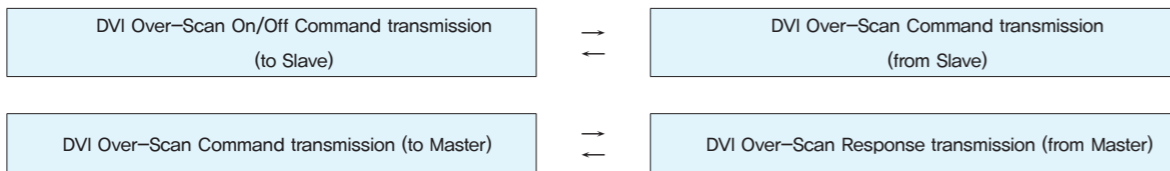

3.21. Get Temperature Status (for IP Board): Only Master

– Command for acquiring temperature information of IP Board.
 – It is usable only at Power on status and only Master is operating.
 – Send to MPDP

Value	STX	CMD	Length	Data		ETX
				ID	M/S	
	0x02	0x7F	0x02	Variable	0x01	0x03

* ID range(Program): 0x01(1) ~ 0xFF(255) * M/S: Since it is only Master, "0x01" Value is transmitted..
 * It is not applicable as "Broad-cast" command.

– Receive from MPDP

Value	STX	CMD	Length	Data			Check Sum	ETX
				ID	M/S	Temperature Values		
	0x02	0xF7	0x04	Variable	0x01	...	Variable	0x03

Temp.0	Temp.1
Variable	Variable

* ID range(Program): 0x01(1) ~ 0xFF(255) * M/S: Since it is only Master, "0x01" Value is transmitted..
 * Temperature Values (Temp.0, Temp.1)
 – 0(0x00): 0°C ~ 127(0x7F): 127°C
 – 128(0x80): -1°C ~ 254(0xFE): -127°C
 – 0xFF: Temp. Sensor Error
 * Check Sum: Execute "Not" operation after adding all the values in "STX~Data" area.

– "Get Temperature Status" Communication Sequence

* Wait for 500msec for response after sending the command. If there is no response, it is recommended to resend the command.
 * It is recommended that not sending the other command or changing input resolution during command transmission.



3.22. Over-Temperature Shut-down Control : Only Master

– Commands for automatic power off making MPDP set stand-by and OSD warning method, if IP board temperature is 95°C or higher.

– CMD

* 0x64(Over Temperature Shut-down Enable)
 : In case IP board temperature is 95°C or higher, display warning signal "High Temperature" in red for 1 minute at the lower left corner of MPDP and power off automatically (Stand-by mode.)
 * 0x65(Over Temperature Shut-down Disable)
 : In case IP board temperature is 95°C or higher, display warning signal "High Temperature" in red for 3 seconds at the lower left corner of MPDP and repeat the warning every 60 seconds. (No automatic power off)

– The commands are available only for power on status and master.

– The initial configuration is "Over Temperature Shut-down Enable."

– Send to MPDP

Value	STX	CMD	Length	Data		ETX
				ID	M/S	
	0x02	Variable	0x02	Variable	0x01	0x03

* ID range(Program): 0x01(1) ~ 0xFF(255)
 * M/S: "0x01" value should be sent because they are the master only commands.

– Receive from MPDP

Value	STX	CMD	Length	Data		Check Sum	ETX
				ID	M/S		
	0x02	Variable	0x02	Variable	0x01	Variable	0x03

* ID range(Program): 0x01(1) ~ 0xFF(255)
 * M/S: "0x01" value should be received, because they are the master only commands.
 * Check Sum: Add the sum from STX to Data and execute "Not" operation.

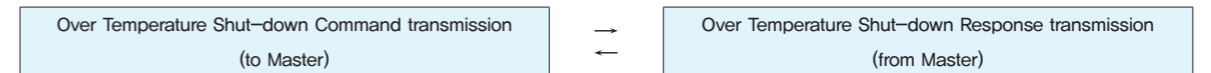

※ Attachment : ASCII to HEX Conversion Table

ASCII	HEX	ASCII	HEX	ASCII	HEX	ASCII	HEX	ASCII	HEX	ASCII	HEX	ASCII	HEX
STX	02	*	2A	9	39	H	48	W	57	f	66	u	75
ETX	03	+	2B	:	3A	I	49	X	58	g	67	v	76
Esc	1B	,	2C	;	3B	J	4A	Y	59	h	68	w	77
CR	0D	-	2D	<	3C	K	4B	Z	5A	i	69	x	78
LF	0A	.	2E	=	3D	L	4C	[5B	j	6A	y	79
Space	20	/	2F	>	3E	M	4D	\	5C	k	6B	z	7A
!	21	0	30	?	3F	N	4E]	5D	l	6C	{	7B
"	22	1	31	@	40	O	4F	^	5E	m	6D		7C
#	23	2	32	A	41	P	50	-	5F	n	6E	}	7D
\$	24	3	33	B	42	Q	51	`	60	o	6F	~	7E
%	25	4	34	C	43	R	52	a	61	p	70	DEL	7F
&	26	5	35	D	44	S	53	b	62	q	71		
'	27	6	36	E	45	T	54	c	63	r	72		
(28	7	37	F	46	U	55	d	64	s	73		
)	29	8	38	G	47	V	56	e	65	t	74		

7. Other tips

7.1. Before calling for service

Before calling for any repair, check the following and then refer to a near A/S center.

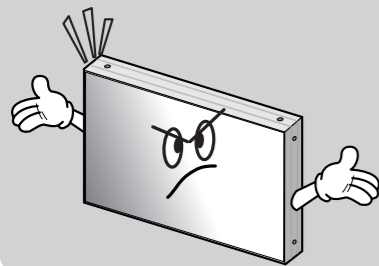

► "Tick" sound from the main body.

- If there is no problem with the screen or sound, the "tick" sound is likely to result from the cabinet lightly shrinking with the change of room temperature. The sound does not affect product's performance.

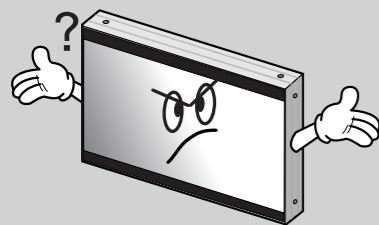

► No image at upper and lower part of the screen.

- As for a screen which is over 16:9 in width (such as cinema-sized one), no image may be displayed at upper and bottom part of the screen.

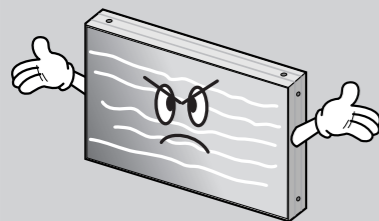

► Speckles or white lines on the screen

- Check whether the problem is caused by vehicle, streetcar, high-voltage cable or neon sign, which emitting interference wave or electromagnetic induction. Avoid any interfering object.

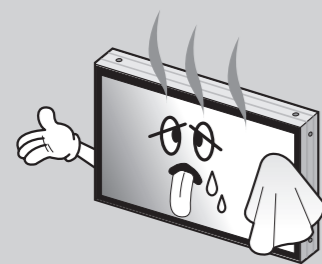

► Screen or PDP Set is hot

- PDP sets or screen can be hot, because basic principle of PDP driving is Plasma discharge between electrodes.
- It is not a defect or a malfunction of the product, you may continue to use the product.

7.2. About Plasma display panel

The followings are phenomena caused by characteristics of the plasma display panel.

Since it is not a fault, you may continue to use the product.

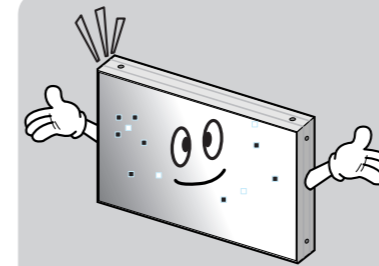

Caution

► Black or twinkling spots on the screen

- Although the plasma display panel is manufactured with high-precision technology, there may exist black or twinkling spots on the screen. Since it is not a fault, you may continue to use the product.

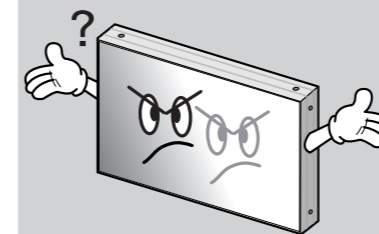

Caution

► Burn-In effect

- Displaying static images such as still video frames or computer screen images for an extended period of time may cause burn-in effect. The burn-in effect may be gradually reduced by displaying full white pattern.
- However, please always be careful in using static images on this product, because such burn-in effect may cause permanent damages in some cases.

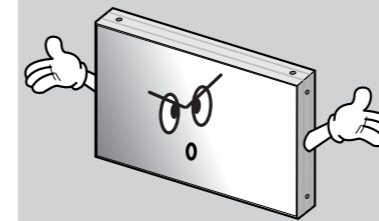

Caution

► Noise from the inside

- When you turn on the product slight buzzing sound may be heard from the rear of display panel. Since it is not a fault, you may continue to use the product.

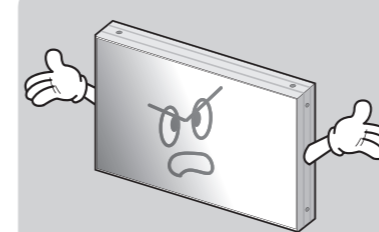

Caution

► Screen decolorization

- Optical film that is attached on the panel can be slightly decolorized after long time of use. The degree of decolorization may vary depending on display contents and conditions. It is due to the characteristics of the film, but it is not a defect. (It is caused by chemical characteristics of the film.)

8. Applicable DVI signals

- When you select PC for input source, it does not support DTV signal.

Resolution	V-Freq. (Hz)	H-Freq. (KHz)	Remarks
640 x 480	60	31.46	VESA DMT
800 x 600	50	30.99	VESA CVT
800 x 600	60	37.88	VESA DMT
853 x 480	50	31.50	-
853 x 480	60	31.50	VESA DMT
1024 x 768	60	48.36	
1280 x 768	60	47.69	VESA CVT
1280 x 960	60	60.00	VESA DMT
1280 x 1024	50	52.67	VESA CVT
1280 x 1024	60	63.97	VESA DMT
1360 x 768	50	39.56	VESA CVT
1360 x 768	60	47.71	VESA DMT
1366 x 768	50	48.79	-
1366 x 768	60	48.77	-
1400 x 1050	60	65.317	VESA CVT
1600 x 900	50	46.39	VESA CVT
1600 x 900	60	55.99	VESA CVT
1600 x 1200	50	61.79	VESA CVT
1600 x 1200	60	75.00	VESA DMT
1706 x 960	60	59.57	

9. Specification

Model Name		OPM-4250	
Power supply		100 ~ 240V AC, 50/60Hz	
Power consumption	Average (Typical)	300W	
	Max	360W	
Plasma display panel		106Cm (42), 16:9 Aspect Ratio	
Peak Brightness		1,700 cd/m ² (Without film)	
Burn-in effect		Burn-In Compensation (BIC)	
Front filter		AGAR (Anti-Glare, Anti-Reflection)	
Number of pixels		853(H) X 480(V)	
Seam gap (In case of multi formation)		2.2mm	
Environmental condition	Temperature	0° C ~ 35° C	
	Humidity	20% ~ 70%	
Input /output Terminal		Input	Output
DVI 1 (HDCP Available)		DVI-D 24pin (female)	DVI-D 24pin (male)
DVI 2 (HDCP Available)		DVI-D 24pin (female)	DVI-D 24pin (male)
Serial		RS-232C D-sub 9pin(female)	RS-232C D-sub 9pin(male)
External dimension 923.9mm[W] X 521.2mm[H] X 73mm[D]			
Weight		22kg (±1kg)	

※Product design and specification can be changed for quality improvement without prior notice.

Model Name		OPM-4250R	
Power supply		100 ~ 240V AC, 50/60Hz	
Power consumption	Average (Typical)	300W	
	Max	360W	
Plasma display panel		106Cm (42), 16:9 Aspect Ratio	
	Peak Brightness	1,700 cd/m ² (Without film)	
Burn-in effect		Burn-In Compensation (BIC)	
Front filter		AGAR (Anti-Glare, Anti-Reflection)	
Number of pixels		853(H) X 480(V)	
Seam gap (In case of multi formation)		4mm	
Environmental condition	Temperature	0° C ~ 35° C	
	Humidity	20% ~ 70%	
Input /output Terminal		Input	Output
	DVI 1 (HDCP Available)	DVI-D 24pin (female)	DVI-D 24pin (male)
	DVI 2 (HDCP Available)	DVI-D 24pin (female)	DVI-D 24pin (male)
	Serial	RS-232C D-sub 9pin(female)	RS-232C D-sub 9pin(male)
External dimension 925.4mm[W] X 522.7mm[H] X 74.5mm[D]			
Weight		22kg (± 1kg)	

※ Product design and specification can be changed for quality improvement without prior notice.

10. Option Specification

10.1. DVI Converter

Product Name	Specification	
DVI Converter	Power supply	100 ~ 250V AC, 50/60Hz
	Power consumption	40W (MAX)
	Size	405mm(W) X 250mm(D) X 60mm(H)
	Environmental Condition	0°C ~ 40°C, 20 ~80% RH
	Weight	3Kg

Input/Output Specification

	Terminal Name	Terminal Specification	
Video Input Signal	Composite Video	BNC 1Pin	NTSC, PAL, SECAM
	S-Video	DIN 4Pin	NTSC, PAL, SECAM
	Component Video	BNC 3Pin	480i, 576i, 480p, 576p, 720p, 1080i, 1080p
	Analog RGB	D-Sub 15Pin (Female)	VGA, SVGA, WVGA, XGA, SXGA, WXGA, UXGA Horizontal Freq. : 15.5Khz ~ 75Khz Vertical Freq. : 50/60Hz
	DVI / HDMI	DVI-D 24Pin (Female) / HDMI 29Pin	480p, 576p, 720p, 1080i, 1080p VGA, SVGA, WVGA, XGA, SXGA, WXGA, UXGA Horizontal Freq. : 15.5Khz ~ 75Khz Vertical Freq. : 50/60Hz
Video Output Signal	SDI	BNC 1Pin	SMPTE 259M-C, SMPTE 292M, SMPTE 424M, SMPTE 425 (Level A & B)
	DVI	DVI-D 24Pin (Female)	640X480-60/85, 800X600-50/60/85, 853X480-50/60, 1027X768-60/85, 1280X1024-50/60, 1600X900-50/60, 1600X1200-50/60, 1706X960-60
Control Method	RS-232C	D-Sub 9Pin (Female)	Baud Rate : 115200 Max ± 15V
	Ethernet	RJ-45	TCP/IP
	Key Pad		Input Souce Select Hot Key, Output Resolution Select Hot Key, Navigation Key(OSD), Control Channel Select, Communication Method Select.
Display	C-LCD	2X16	Input Souce, Output Resolution Display

※ Specification can be changed without prior notice to improve product quality.

※ Ethernet communication is available when it is used with New MFC.

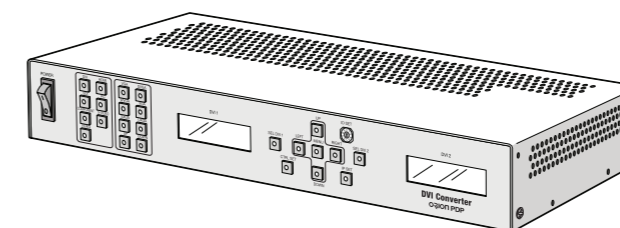

10.2. New MFC

Product Name	Specification	
Remote Controller	Name	MPDP REMOTE CONTROL
	Power	1.5V Battery(AAA) 2EA
	Size	55(W) x 190(L) x 25(H) mm
	Environmental Condition	-10°C ~ 40°C
	Weight	130g
NEW MFC	Voltage	+5~9V(DC), 1.25W (MAX)
	Power Consumption	250mA(Max, +5~9V)
	Size	58(W) x 216(L) x 46(H) mm
	Environmental Condition	0°C ~ 40°C, 20 ~80% RH
	Weight	480g
Adapter	Size	35(W) x 80(L) x 86(H) mm
	Input	90~264V(47~63Hz)
	Output	5V, 2000mA
	Output Jack	2.1φ (Internal diameter):Vcc, 5.5φ (External diameter):GND

Input/Output Specification

NEW MFC	Terminal Name	Terminal Specification	
Control Input	RS-232C	D-Sub 9Pin (Female)	Baud Rate : 115200
	Ethernet	RJ-45	TCP/IP
	USB	Type B	USB2.0
	IR	Max 15m, left/right 45° (standard : 3m)	
	Key Button	Control Mode Select (IR / Ethernet / RS-232C / USB)	
Control Output	RS-232C (4ea)	D-Sub 9Pin (Male)	Baud Rate : 115200 Max ±15V
MPDP ID Setting	7-Segment LED	1~99	MPDP Horizontal Number, Vertical Number

- Minimum interval between button input: 0.6 second

※ Specification can be changed without prior notice to improve product quality.

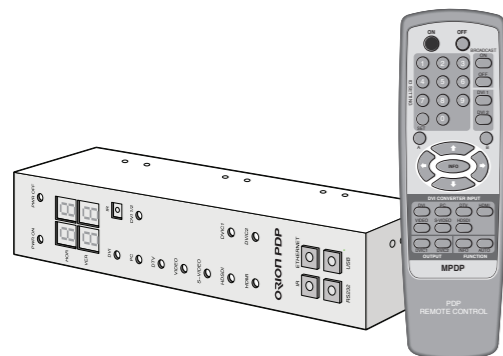

Memo

Memo